

SIGMA CORE 300/400/550 COMPACT/S

Brugsvejledning

User guide

Betriebsanleitung

Guide de l'utilisateur

Bruksanvisning

Guida per l'utilizzatore

Gebruikershandleiding

Käyttöohje



MIGATRONIC

50115076 A Valid from 2023 week 46

Dansk	3
English.....	13
Deutsch.....	23
Français	33
Svenska	43
Italiano	53
Nederlands.....	63
Suomi	73

Tilslutning og ibrugtagning

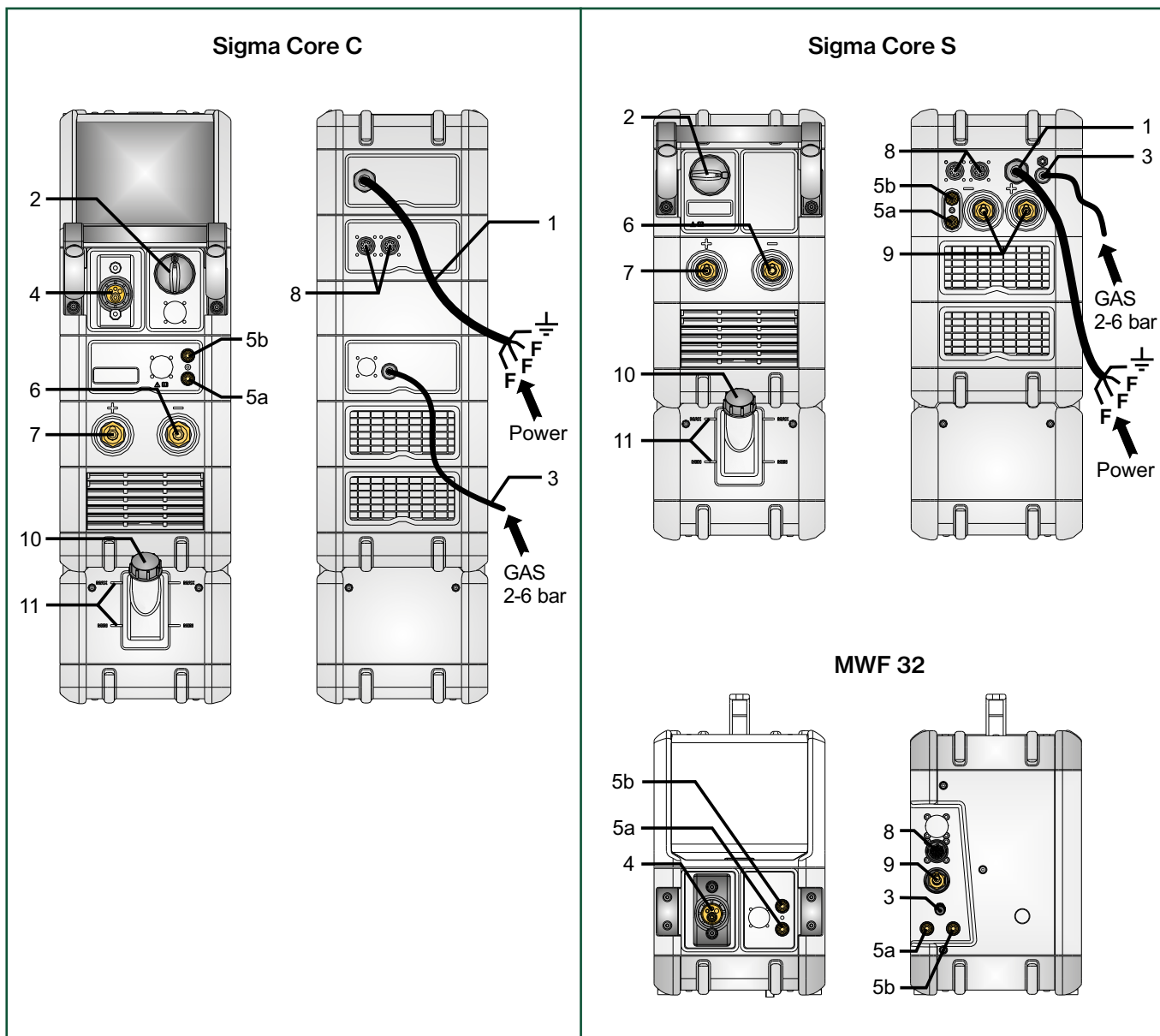

1. Nettilslutning
2. Tænd - sluk knap on/off
3. Tilslutning beskyttelsesgas
4. Tilslutning - svejseslange
- 5a. Tilslutning køleslange, fremløb (blå)
- 5b. Tilslutning køleslange, tilbageløb (rød)
6. Stelklemme (MIG) eller elektrodeholder-tilslutning (MMA)
7. Stelklemme (MMA) eller elektrodeholder-tilslutning (MMA)
8. Tilslutning CAN og MWF forsyning
9. Tilslutning mellemkabel
10. Påfyldning af kølevæske
11. Aflæsning af kølevæskestand (Min/Max)

Tilslutning og ibrugtagning



Advarsel

Læs advarsel og brugsanvisning omhyggeligt igennem inden installation og ibrugtagning og gem til senere brug.

Installation

Nettilslutning

Tilslut maskinen til den netspænding den er konstrueret til. Se typeskiltet (U_i) bag på maskinen.

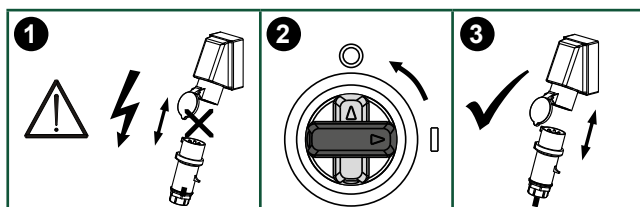
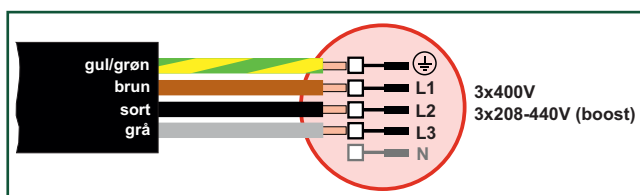

Stabiliseringskit

Strømkilden kan konfigureres med et stabiliseringskit som beskyttelse mod større spændingsvariation, f.eks. ved generatortbrug, hvor maskinen er tilkoblet separat netforsyning.

Tilslutning af beskyttelsesgas

Gasslangen, som udgår fra bagsiden af maskinen (3), tilsluttes en gasforsyning med en reduktionsventil (2-6 bar). (Obs. Nogle typer reduktionsventiler kan kræve højere udgangstryk end 2 bar for at fungere optimalt). En/to gasflasker kan fikseres bag på vognen.

Gasforbrug

Afhængigt af svejseopgave, gastype og svejse søm kan gasforbruget typisk variere fra 6-7 l/min. ved lave ampere (<25A) og op til 27 l/min. ved maks. ampere.

Materialeforbrug

Materialeforbrug kan beregnes ved at lave beregningen svejsetid i minutter x trådhastighed (m/min) x vægt pr. meter på det aktuelle tilsatsmateriale.

Tilslutning af elektrodeholder for MMA

Elektrodeholder og stekabel tilsluttes plusudtag (10) og minusudtag (8). Polariteten vælges efter elektrodeleverandørens anvisning.

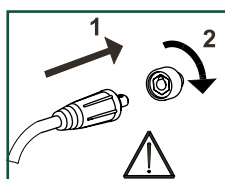

Vigtigt!

Når stekabel og svejse slang tilsluttes maskinen, er god elektrisk kontakt nødvendig, for at undgå at stik og kabler ødelægges.

Tilslutning af svejse slang

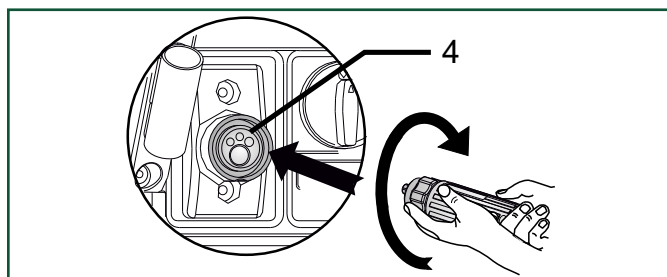

Anbefalede kabelstørrelser

Svejestrøm	DC	PULS
200 A	35 mm ²	35 mm ²
300 A	50 mm ²	70 mm ²
400 A	95 mm ² / 2x50 mm ²	95 mm ² / 2x50 mm ²
550 A	2x70 mm ²	2x70 mm ²

Svejseproces	Afstand til arbejdslemne (a+b)	Total kabellængde i svejsekredsløb (a+b+c)
MIG - puls	10 m	20 m
MIG - ingen puls	30 m	60 m

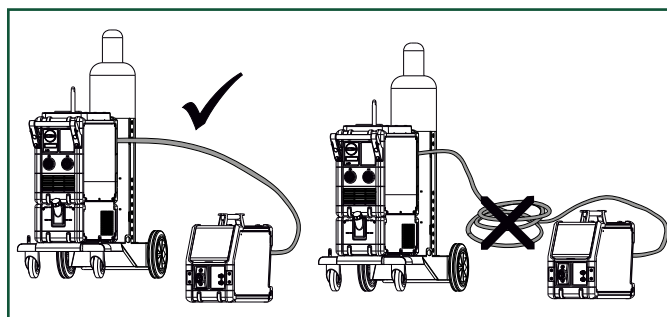
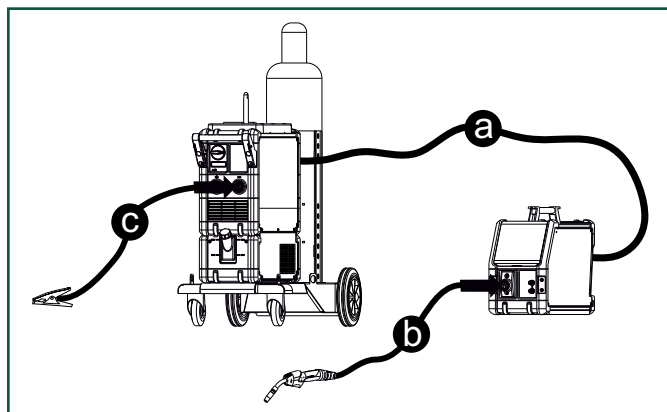

ADVARSEL

Når der trykkes på svejse slangens kontakt/tast er der spænding på svejsetråden/elektroden.

Tilslutning og ibrugtagning

Løfteanvisning

Når maskinen løftes, skal løftepunkterne, som vises på figuren, anvendes.

Maskinen må ikke løftes med monteret gasflaske!

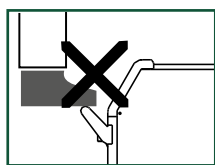
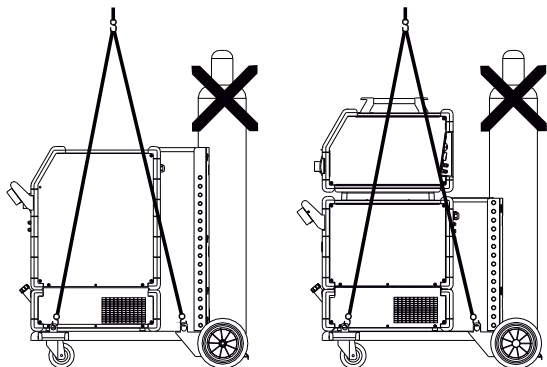

Løft ikke maskinen i håndtaget.
Træd ikke op på håndtaget.

Justering af trådbremse

Bremser justeres så stramt at trådrullen standser inden svejsetråden kører ud over kanten på rullen. Bremskraften er afhængig af vægten på trådrullen, og trådhastigheden. Fabriksindstillet til 15kg.

Justering:

- Afmonter drejeknappen ved at stikke en tynd skruetrækker ind bagved knappen og ryk derefter knappen ud.
- Juster trådbremser ved at spænde eller løsne låsemøtrikken på trådnavets aksel.
- Monter drejeknappen igen.

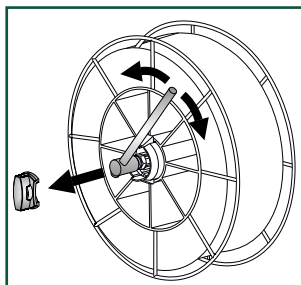

Rangering

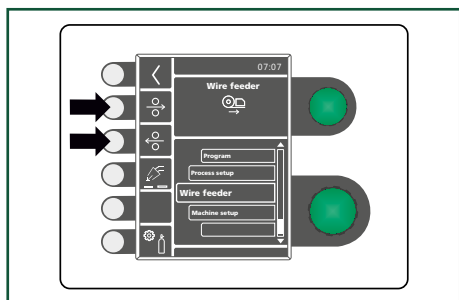
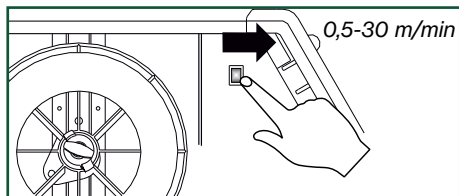

MCU udluftning

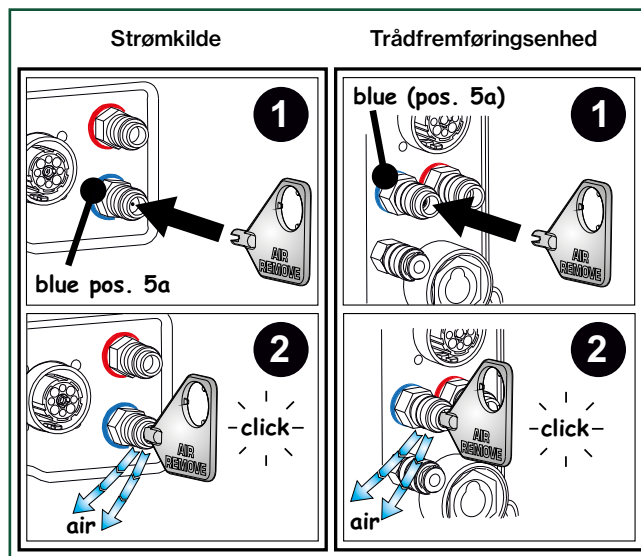

Låse- og drejefunktion MWF

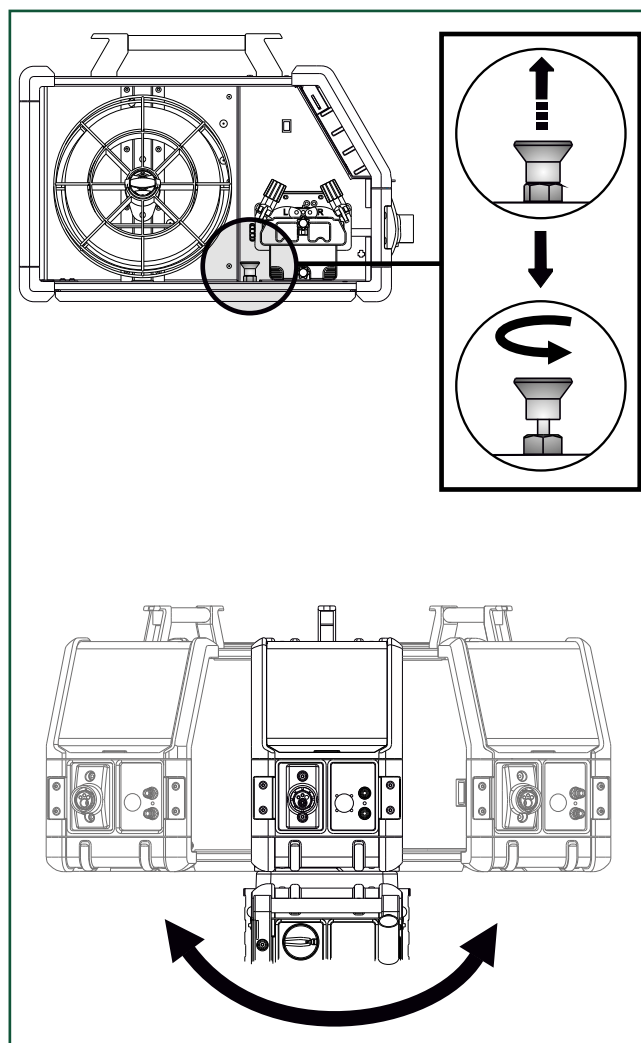

Tilslutning og ibrugtagning

Montering af dele i trådfremføring

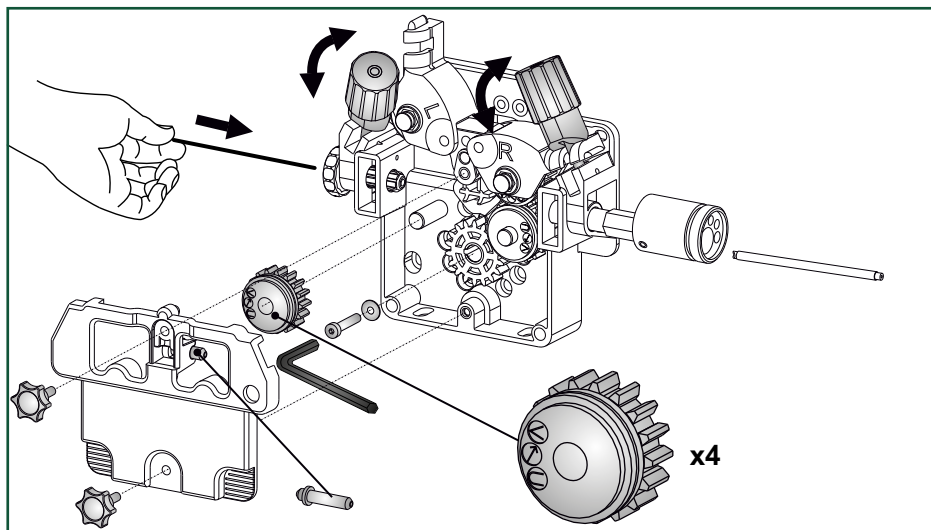

Fingerskruens tryk indstilles, således at trådtrisserne netop glider på tråden, når denne bremses ved kontaktdysen

Software opdatering

- Indsæt SD-kortet
- Tænd maskinen
- Vent indtil enheden indikerer, at opdatering er afsluttet
- Sluk maskinen og tag SD-kortet ud
- Maskinen er nu klar til brug

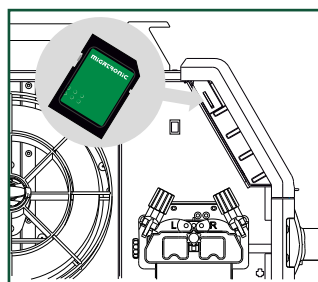

Strømkilde og alle tilkoblede enheder får den nye software indlæst.

Software kan downloades fra <http://migatronic.com> til et SD-kort. SD-kortets filsystem skal være formateret til FAT32.

VIGTIGT:

Software skal gemmes i mappestrukturen: //MIGA_SW/SIGMA/

Specielle funktioner

Software / Licenser

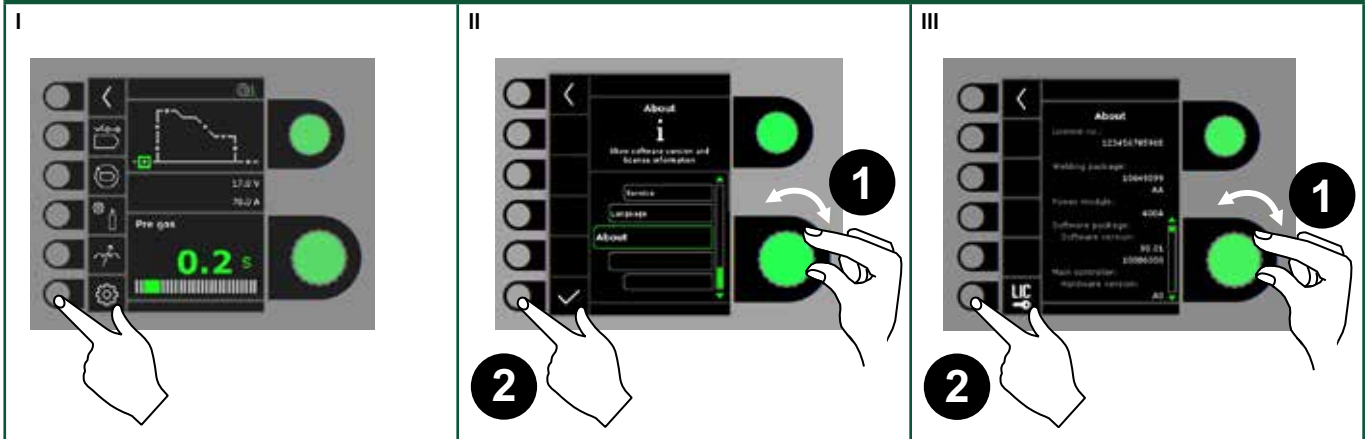

Kabelkompensering (kalibrering af modstand i svejseblange)

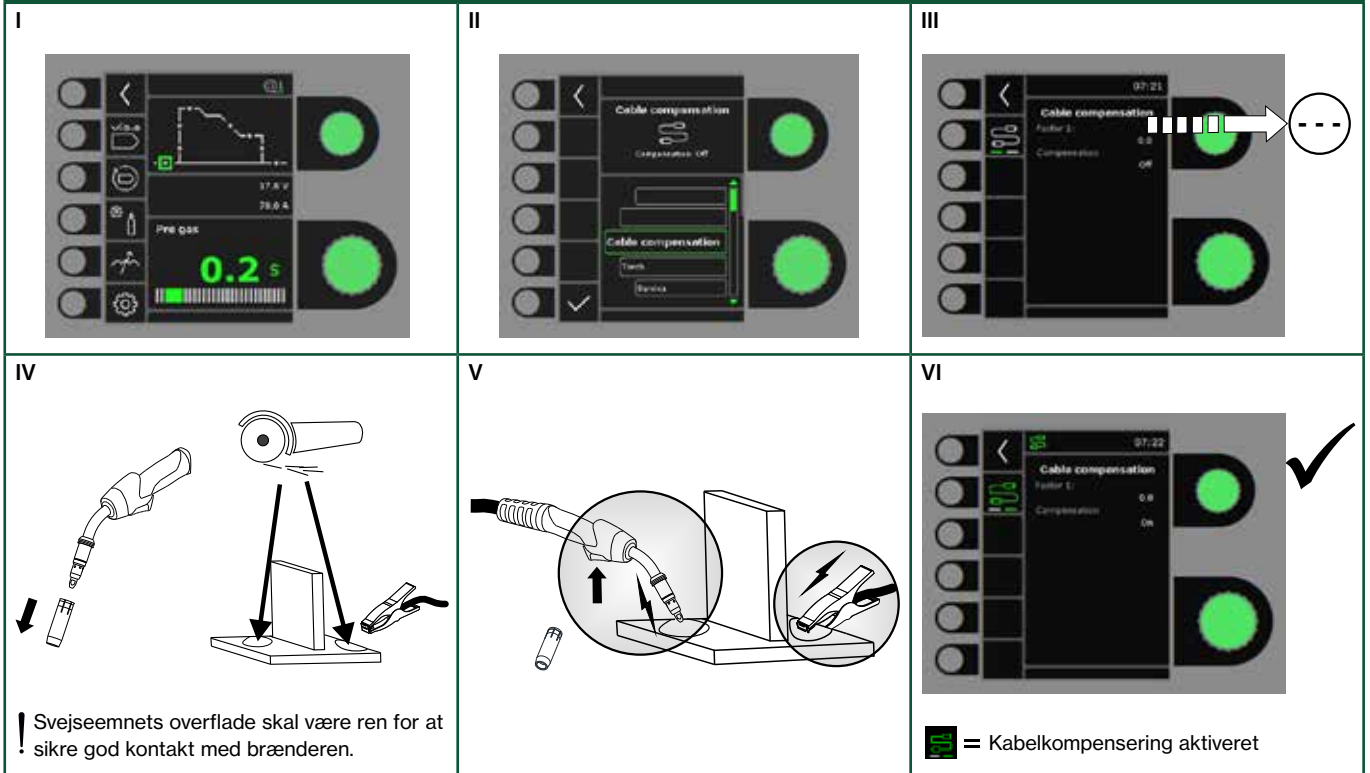

Specielle funktioner

Kalibrering af gasflow (ikke alle modeller)

<p>I</p>	<p>II</p>	<p>III</p>
<p>IV</p>	<p>V</p>	

Brænderopsætning

<p>I</p>	<p>II</p>	<p>III</p>
<p>IV</p>		

Fejlhåndtering

SIGMA Core har et avanceret selvbeskyttelsessystem indbygget. Ved fejl lukker maskinen automatisk for gastilførslen, afbryder svejsestrømmen og stopper trådfremførelsen.

Udvalgte fejl:

Kølefejl

Kølefejl vises i tilfælde af at kølevandet ikke kan cirkulere som følge af forkert tilslutning eller tilstopning.

Kontroller at køleslangerne er korrekt tilsluttet, efterfyld vandbeholderen og efterse svejse slang og tilslutningsstudser. Kølefejlen afmeldes med et kort tryk på ✓-knappen.



Gasfejl (IGC)

Gasfejl kan skyldes for lavt eller for højt tryk på gastilførslen.

Kontroller at trykket på gastilførslen er højere end 2 bar og mindre end 6 bar, svarende til 5 l/min og 27 l/min.

Gasfejl kan sættes ud af funktion ved at indstille manuel gasflow til 27 l/min. Gasfejlen afmeldes med et kort tryk på ✓-knappen.

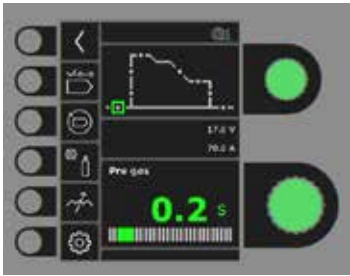
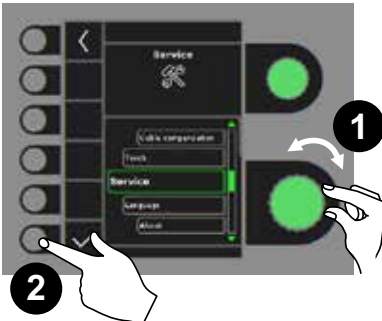
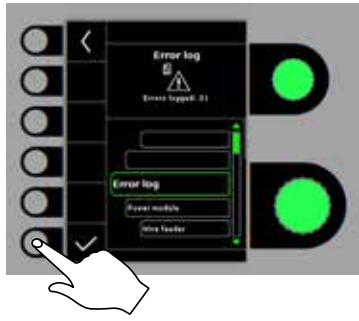
NB! Det er vigtigt, at det angivne tryk på gastilførslen kan opretholdes under svejsning.

Fejllog		
<p>I</p> 	<p>II</p> 	<p>III</p> 
<p>IV</p> <p>Fejllog Alle fejl gemmes i maskinens fejllog under menuen Service. Fejlloggen kan distribueres, når der indsættes et SD-kort og trykkes på følgende tast: Fejlloggen er nu gemt på SD-kortet. Fejlloggen kan nulstilles, når der trykkes på tasten ud for skraldespanden.</p>		

Tekniske data 1

STRØMKILDE	300		400		550	
Netspænding ±15% (50-60Hz), V	3x400		3x400		3x400	
Minimum generatorstørrelse, kVA	16		27		40	
¹ Minimum kortslutningseffekt, MVA	3,7		6,0		9,5	
Sikring, A	16		20		35	
Netstrøm effektiv, A	10,5		17,5		27,2	
Netstrøm max., A	15,4		26,0		39,2	
Effekt 100%, kVA	9,0		12,1		18,9	
Effekt max., kVA	10,7		18,0		27,1	
Effekt tomgang, W	11		12		12	
Virkningsgrad, %	87		89		90	
Powerfaktor	0,90		0,90		0,90	
	MIG	MMA	MIG	MMA	MIG	MMA
Strømområde, A	15-300	15-250	15-400	15-400	15-550	15-550
Intermittens 100% 20°C, A/V	290/28,5	250/30,0	345/31,5	345/33,8	475/37,8	475/39,0
Intermittens maks. 20°C, A/%/V			400/65/34,0	400/65/36,0	550/60/41,5	550/60/42,0
Intermittens 100% 40°C, A/V	220/25,0	210/28,4	300/29,0	300/32,0	430/35,5	430/37,2
Intermittens 60% 40°C, A/V	230/25,5	220/28,8	370/32,5	370/34,8	510/39,5	510/40,4
Intermittens maks. 40°C, A/%/V	300/25/29,0	250/35/30,0	400/50/34,0	400/45/36,0	550/50/41,5	550/50/42,0
Tomgangsspænding, V	50-60		65-75		75-80	
² Anvendelsesklasse	S/CE		S/CE		S/CE	
³ Beskyttelsesklasse	IP23S		IP23		IP23	
Normer, C	IEC60974-1, IEC60974-5, IEC60974-10 Cl. A					
Normer, S	IEC60974-1, IEC60974-10 Cl. A					
Dimensioner C (HxBxL), mm	700x260x735		700x260x735		700x260x735	
Dimensioner S (HxBxL), mm	454x260x735		454x260x735		454x260x735	
Vægt C / S, kg	36,9 / 26		52 / 35		53 / 36	

STRØMKILDE	300 Boost				400 Boost			
Netspænding ±10% (50-60Hz), V	3x208-380		3x380-440		3x208-380		3x380-440	
Minimum generatorstørrelse, kVA	16		16		25		25	
¹ Minimum kortslutningseffekt, MVA	1,7		3,75					
Sikring, A	20		16		25-50		25-50	
Netstrøm effektiv, A	19,5		10,6		22,0		11,7	
Netstrøm max., A	31,6		16,2		45,0		23,5	
Effekt 100%, kVA	7,1		7,0		8,3		8,1	
Effekt max., kVA	11,0		10,6		16,7		16,3	
Effekt tomgang, W	45		16		60		56	
Virkningsgrad, %	82		87		84		88	
Powerfaktor	0,95		0,95		0,96		0,95	
	MIG	MMA	MIG	MMA	MIG	MMA	MIG	MMA
Strømområde, A	15-300	15-250	15-300	15-250	15-400	15-400	15-400	15-400
Intermittens 100% 20°C, A/V	250/26,5		250/26,5		300/29,0	300/32,0	300/29,0	300/32,0
Intermittens maks. 20°C, A/%/V	300/40/29,0		300/40/29,0		400/30/34,0	400/30/32,0	400/30/34,0	400/30/32,0
Intermittens 100% 40°C, A/V	200/24,0	200/28,0	200/24,0	200/28,0	250/26,5	220/28,8	250/26,5	220/28,8
Intermittens 60% 40°C, A/V	210/24,5	210/28,4	210/24,5	210/28,4	280/28,0	260/30,4	280/28,0	260/30,4
Intermittens maks. 40°C, A/%/V	300/25/29,0	250/35/30,0	300/25/29,0	250/35/30,0	400/25/34,0	400/20/36,0	400/25/34,0	400/20/36,0
Tomgangsspænding, V	50-60				70-75			
² Anvendelsesklasse	S/CE				S/CE			
³ Beskyttelsesklasse	IP23S				IP23			
Normer, C	IEC60974-1, IEC60974-5, IEC60974-10 Cl. A				IEC60974-1, IEC60974-5, IEC60974-10 Cl. A			
Normer, S	IEC60974-1, IEC60974-10 Cl. A				IEC60974-1, IEC60974-10 Cl. A			
Dimensioner C (HxBxL), mm	700x260x735				900x260x735			
Dimensioner S (HxBxL), mm	454x260x735				654x260x735			
Vægt C / S, kg	45 / 34				66 / 49			

- 1) Dette udstyr er i overensstemmelse med EN / IEC61000-3-12:2014 (/ 2011), forudsat at nettets kortslutningseffekt S_{sc} ved tilslutningsstedet er større end eller lig med de opgivne data i ovenstående skema. Installatøren eller brugeren af udstyret er ansvarlig for at sikre, evt. i samråd med forsyningsdistributøren, at udstyret er tilsluttet til en netforsyning med en kortslutningseffekt S_{sc} større end eller lig med de opgivne data i ovenstående skema.
- 2) **S** Maskiner opfylder de krav der stilles under anvendelse i områder med forøget risiko for elektrisk chok
- 3) Maskinen er godkendt til indendørs og udendørs brug i henhold til beskyttelsesklasse IP23 / IP23S.
IP23S: Maskinen kan opbevares men er ikke beregnet til at blive brugt udendørs under nedbør, medmindre den er afskærmet.

Tekniske data 2

TRÅDBOKS MWF	
Trådfremføringshastighed, m/min	0,5-30,0
Brændertilslutning	EURO
Trådspolediameter, mm	300
Trådrulle, kg	5-18
Intermittens 100 % 40°C, A	430
Intermittens 60% 40°C, A	500
Intermittens maks. 40°C A/%	550/50
³⁾ Beskyttelsesklasse	IP23
Tr addediameter, mm	0,6-1,6
Gastryk, MPa (bar)	0,6 (6,0)
Dimensioner (HxBxL), mm	457x260x672,5
Vægt, kg	14,0
Normer	IEC60974-5, IEC60974-10 CL. A

KØLEMODUL MCU 1300	
Køleeffekt (1 l/min), W	1300
Køleeffekt (1,5 l/min), W	1600
Tankkapacitet, liter	5
Flow, bar - °C - l/min	3,0-60-1,5
Maks. tryk, bar	5
Normer	IEC60974-2, IEC60974-10 CL.A
Dimensioner (HxBxL), mm	207x260x680
Vægt, kg	20

EU-OVERENSSTEMMELSESERKLÆRING



MIGATRONIC A/S
Aggersundvej 33
9690 Fjerritslev
Danmark

erklærer, at nedennævnte maskine

Type: SIGMA CORE

er i overensstemmelse med bestemmelserne i

direktiverne: 2014/35/EU

2014/30/EU

2011/65/EU

Europæiske EN IEC60974-1:2018/A1:2019

standarder: EN IEC60974-2:2019

EN IEC60974-5:2019

EN IEC60974-10:2014/A1:2015

Forordning: 2019/1784/EU

Udfærdiget i Fjerritslev 01.10.2022

Kristian M. Madsen
CEO

- 1) Dette udstyr er i overensstemmelse med EN / IEC61000-3-12:2014 (/ 2011), forudsat at nettets kortslutningseffekt Ssc ved tilslutningsstedet er større end eller lig med de opgivne data i ovenstående skema. Installatøren eller brugeren af udstyret er ansvarlig for at sikre, evt. i samråd med forsyningsdistributøren, at udstyret er tilsluttet til en netforsyning med en kortslutningseffekt Ssc større end eller lig med de opgivne data i ovenstående skema.
- 2) **S** Maskiner opfylder de krav der stilles under anvendelse i områder med forøget risiko for elektrisk chok
- 3) Maskinen er godkendt til indendørs og udendørs brug i henhold til beskyttelsesklasse IP23 / IP23S.
IP23S: Maskinen kan opbevares men er ikke beregnet til at blive brugt udendørs under nedbør, medmindre den er afskærmet.

Connection and start-up

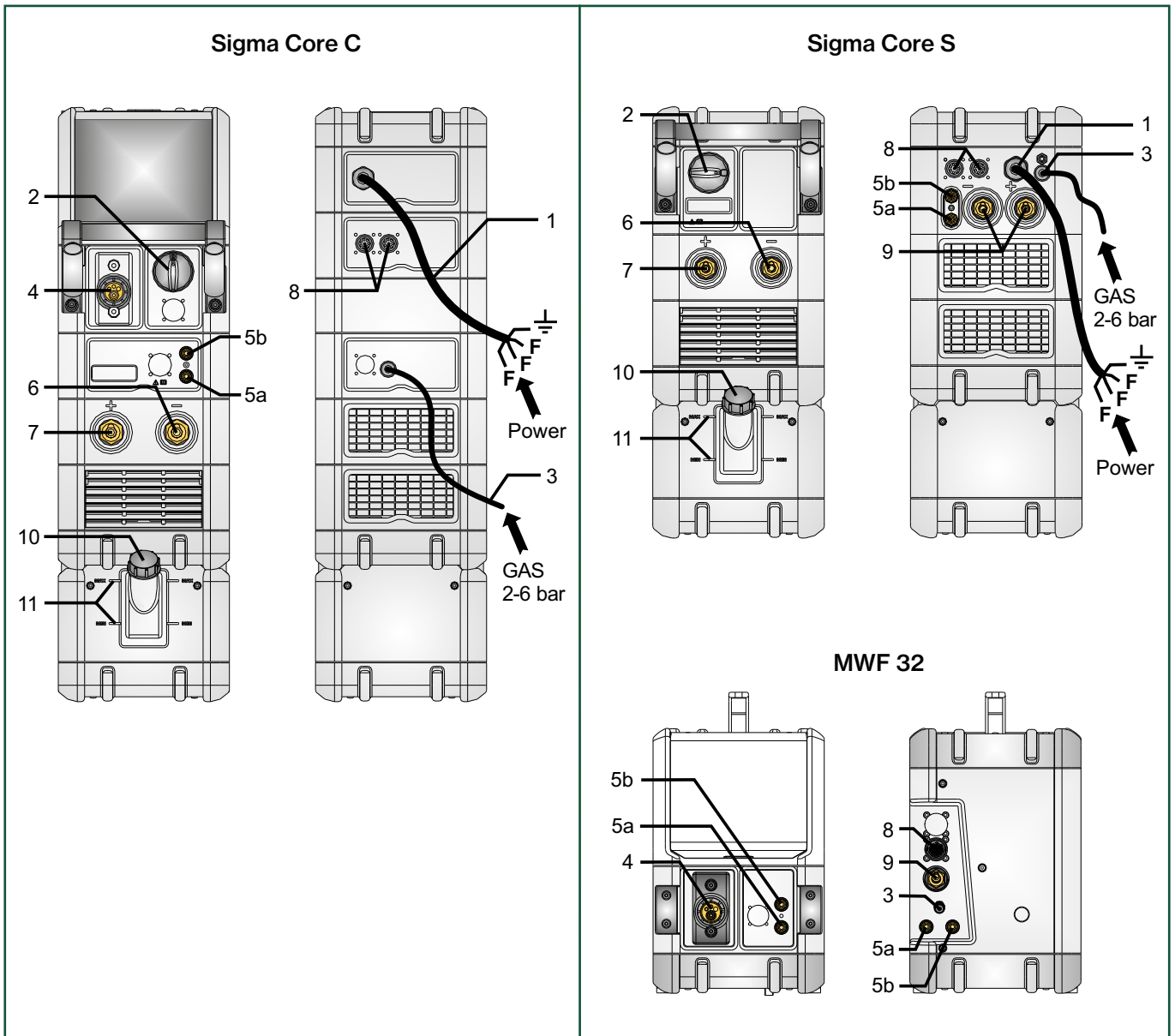

1. Mains connection
2. Power switch on/off
3. Connection of shielding gas
4. Connection of welding hose
- 5a. Connection of cooling hose, flow (blue)
- 5b. Connection of cooling hose, return (red)
6. Connection of earth clamp (MIG) or electrode holder (MMA)
7. Connection of earth clamp (MMA) or electrode holder (MMA)
8. CAN connection and MWF supply
9. Connection of intermediary cable
10. Refill of cooling liquid
11. Cooling liquid level control (Min/Max)

Connection and start-up



Warning

Read warning notice and instruction manual carefully prior to initial operation and save the information for later use.

Permissible installation

Mains connection

Connect the machine to the correct mains supply. Please read the type plate (U_i) on the rear side of the machine.

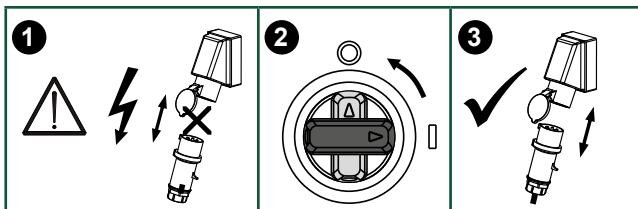
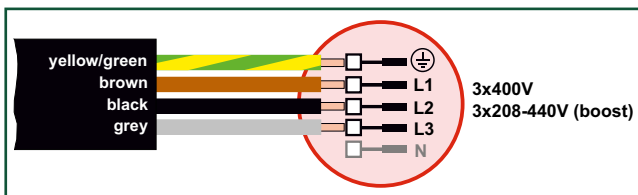

Voltage stabilisation kit

The power source is configurable with a voltage stabilisation kit as a safeguard against larger voltage variations, e.g. in case of generator use where the machine is connected to a separate power supply.

Connection of shielding gas

Connect the gas hose, which branches off from the back panel of the welding machine (3), to a gas supply with pressure regulator (2-6 bar). (Note: Some types of pressure regulators require an output pressure of more than 2 bar to function optimally). One/two gas cylinders can be mounted on the bottle carrier on the back of the trolley.

Gas consumption

Depending on the welding task, gas type and seam design, the gas consumption will vary in ranges from 6-7 l/min at low amperages (<25A) and up to 27 l/min at max. amperage.

Material consumption

Material consumption can be estimated by calculating welding time in minutes times wire feed speed (m/min) times weight per meter of the welding consumables in use.

Connection of electrode holder for MMA

The electrode holder and earth cable are connected to plus connection (10) and minus connection (8). Observe the instructions from the electrode supplier when selecting polarity.

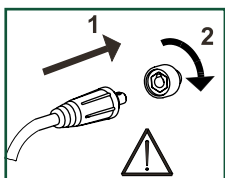

Important!

In order to avoid destruction of plugs and cables, good electric contact is required when connecting earth cables and welding hoses to the machine.

Connection of welding hose

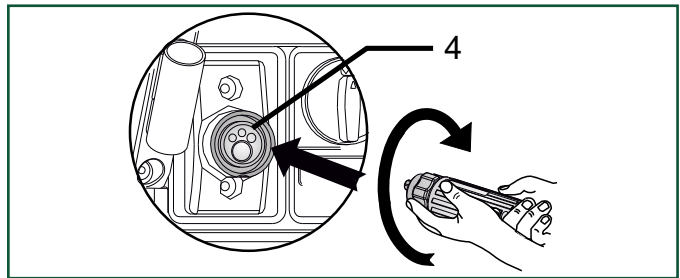

Recommended cable dimensions

Welding current	DC	PULSE
200 A	35 mm ²	35 mm ²
300 A	50 mm ²	70 mm ²
400 A	95 mm ² / 2x50 mm ²	95 mm ² / 2x50 mm ²
550 A	2x70 mm ²	2x70 mm ²

Welding process	Distance to work piece (a+b)	Total cable length in welding circuit (a+b+c)
MIG - pulse	10 m	20 m
MIG - non pulse	30 m	60 m

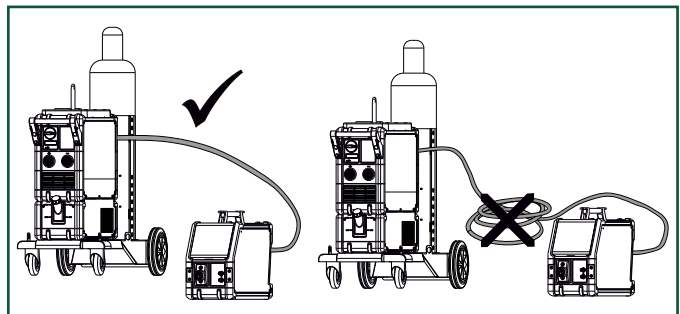
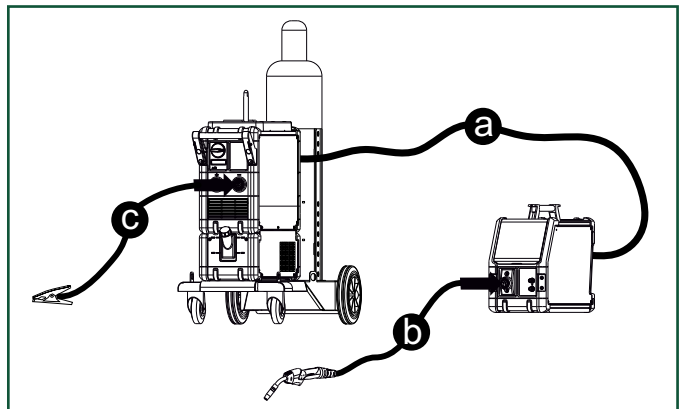

WARNING

When you activate the torch trigger, there is voltage applied to the welding wire and electrode.

Connection and start-up

Lift instructions

The lifting points must be used (please see figure) when lifting the machine. The machine must not be lifted with mounted gas bottle.

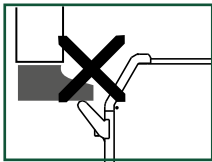
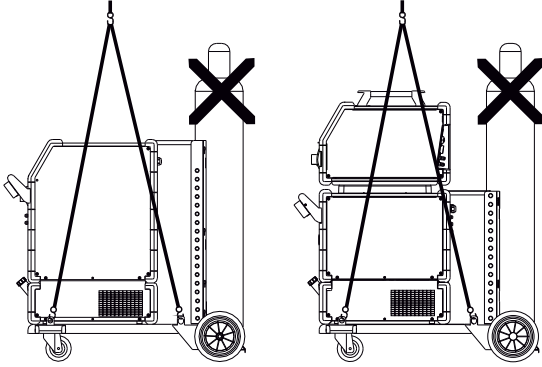

Do not lift the machine by the handle.
Do not step on the handle.

Adjustment of wire brake

The wire brake must be adjusted so as to stop the wire reel before the welding wire runs over the edge of the reel. The brake force depends on the weight of the wire reel and the wire feed speed. Factory setting is 15kg.

Adjustment:

- Dismount the control knob by placing a thin screw driver behind the knob and then pull it out.
- Adjust the wire brake by fastening or loosening the self-locking nut on the axle of the wire hub.
- Remount the control knob.

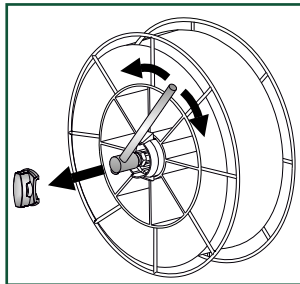

Wire inching

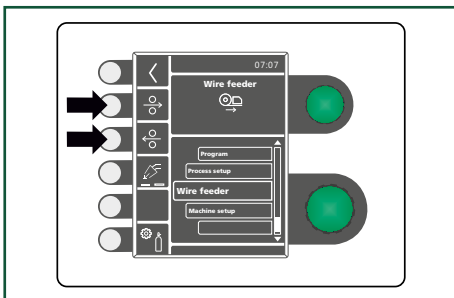
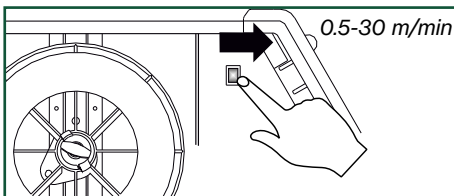

MCU ventilation

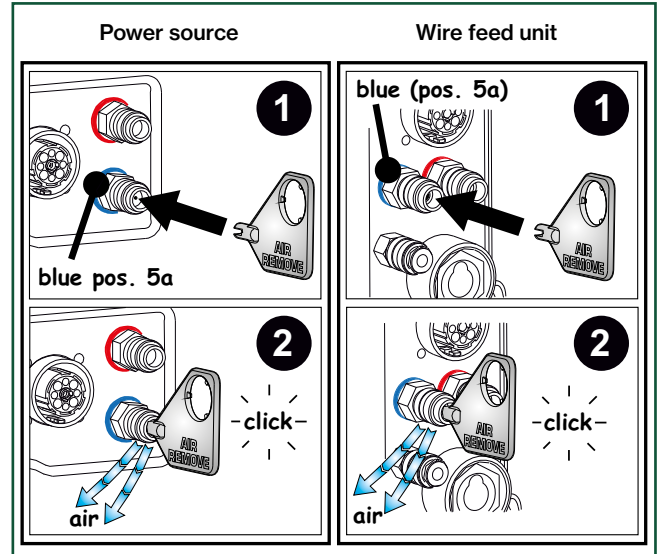

MWF lock-turn function

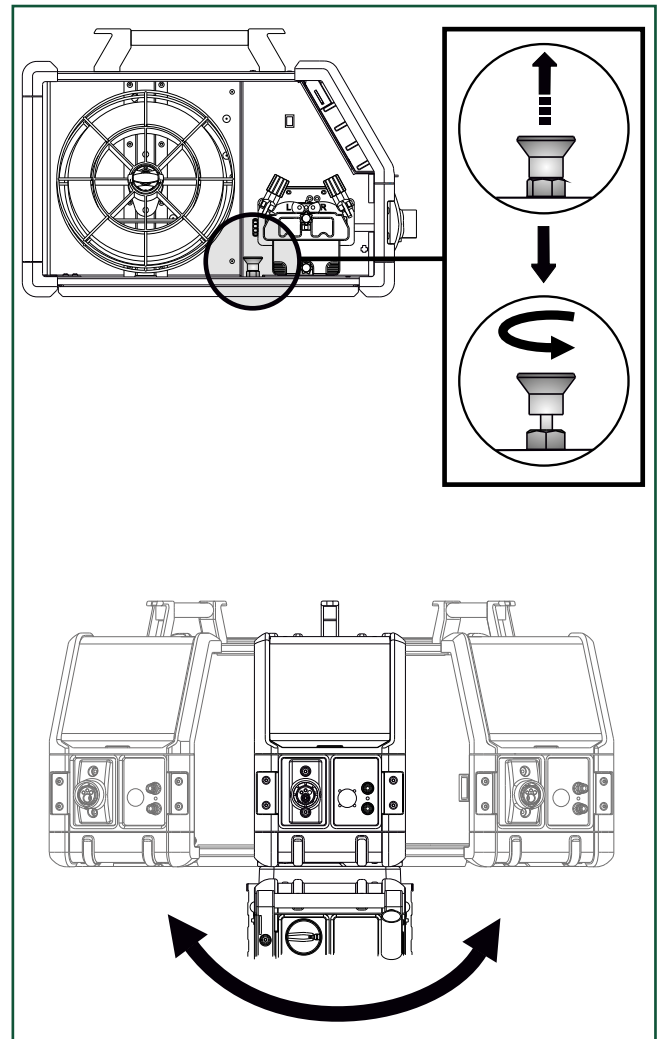

Connection and start-up

Assembly of parts in wire feed unit

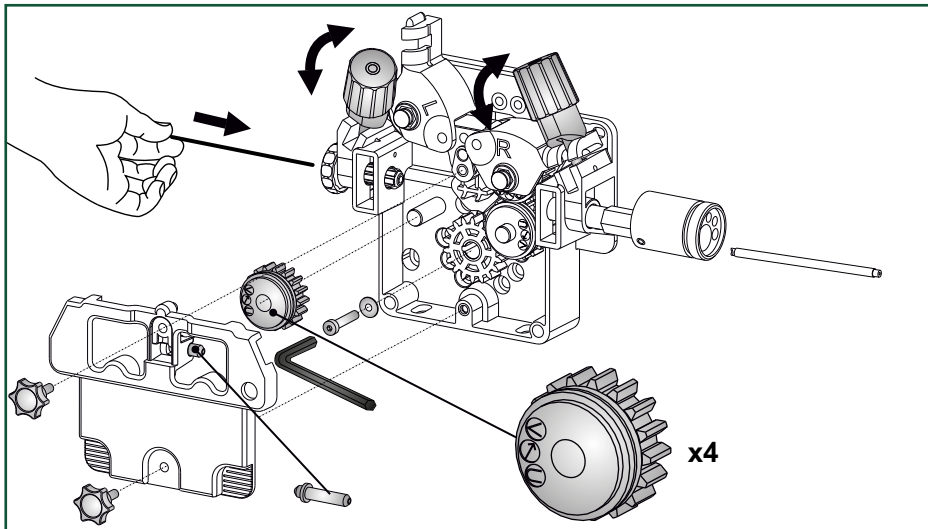

The pressure of the thumbscrew is adjusted to allow the wire feed roll just to slide on the wire when this is stopped at the contact tip

Software update

- Insert the SD-card
- Turn on the machine
- Wait until the unit indicates that the update is complete
- Turn off the machine and remove the SD card
- The machine is now ready for use

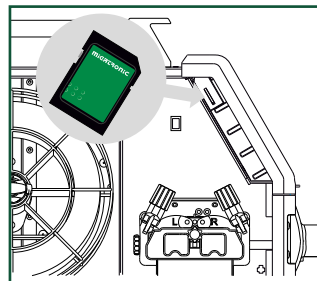

New software will be loaded into power source and all connected units.

The software can be downloaded from <http://migatron.com> to an SD card. The file system of the SD card must be formatted to FAT32.

IMPORTANT:

Save the software in the //MIGA_SW/SIGMA/ file structure.

Special functions

Software / Licenses

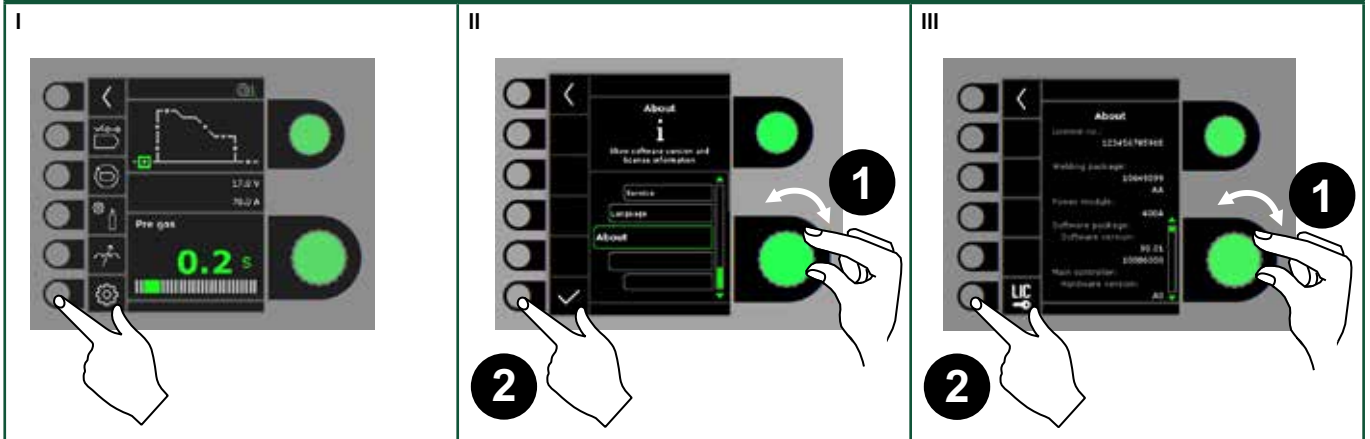

Cable compensation (calibration of resistance in welding hose)

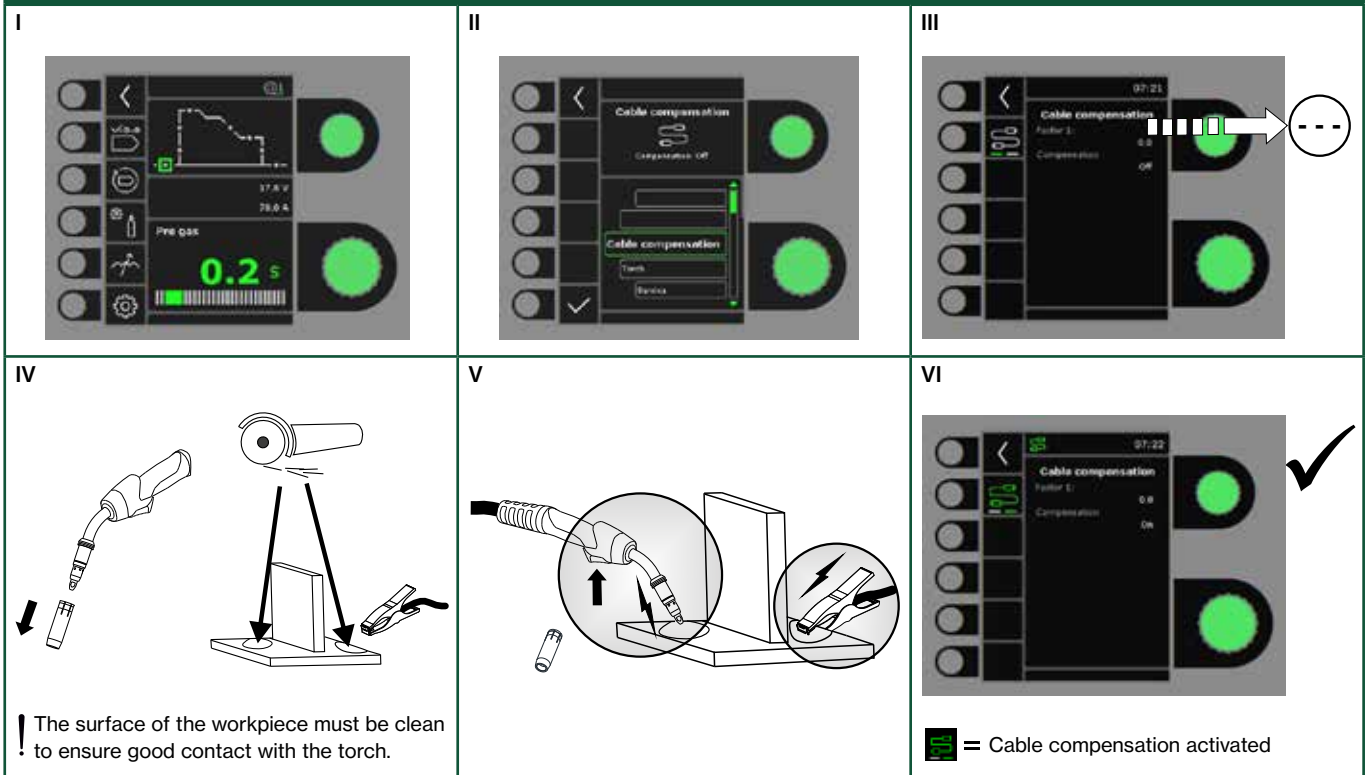

Special functions

Calibration of gas flow (not all models)

<p>I</p>	<p>II</p>	<p>III</p>
<p>IV</p>	<p>V</p>	

Torch setup

<p>I</p>	<p>II</p>	<p>III</p>
<p>IV</p>		

Error handling

SIGMA CORE has a sophisticated built-in self-protection system. The machine automatically stops the gas supply, interrupts the welding current and stops the wire feeding in case of an error.

Selected errors:

Torch cooling fault

Cooling fault is indicated on machines in case of insufficient circulation of the cooling liquid due to faulty connection, defective parts or choking. Check that the cooling hoses are correctly connected, top up the water tank and check welding hose and branches. The cooling fault is cancelled by pressing shortly on the ✓-key pad.



Gas control fault (IGC)

Gas fault exists due to a too low or high gas flow.

Make sure that the pressure on the gas flow is higher than 2 bar and less than 6 bar, corresponding to 5 l/min and 27 l/min.

The fault is disconnected by adjusting the manual gas flow to 27 l/min. The gas fault is reset by a short pressure on the ✓-key pad.

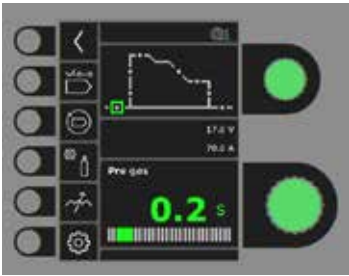
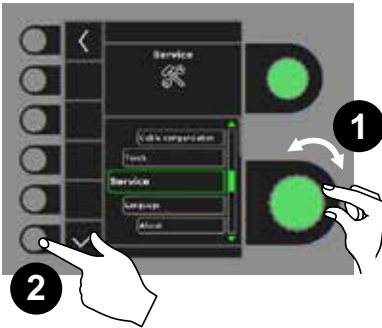
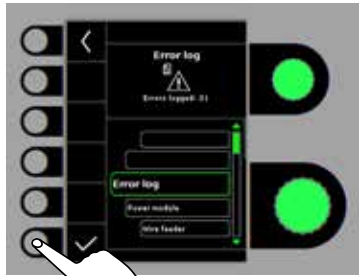
Note: it is important that the stated gas supply can be maintained during welding.

Error log		
<p>I</p> 	<p>II</p> 	<p>III</p> 
<p>IV</p> <p>Error log All errors are saved in the machine error log in the menu Service. The error log can be distributed, when inserting a SD-card and pressing the following key: The error log is now saved at the SD-card. The error log can be reset when pressing the key pad with the trash bin.</p>		

Technical data 1

POWER SOURCE	300		400		550	
Mains voltage $\pm 15\%$ (50-60Hz), V	3x400		3x400		3x400	
Minimum generator size, kVA	16		27		40	
¹ Minimum short-circuit power, MVA	3.7		6.0		9.5	
Fuse, A	16		20		35	
Mains current effective, A	10.5		17.5		27.2	
Mains current max., A	15.4		26.0		39.2	
Power 100%, kVA	9.0		12.1		18.9	
Power max., kVA	10.7		18.0		27.1	
Power open circuit, W	11		12		12	
Efficiency, %	87		89		90	
Power factor	0.90		0.90		0.90	
	MIG	MMA	MIG	MMA	MIG	MMA
Current range, A	15-300	15-250	15-400	15-400	15-550	15-550
Duty cycle 100% 20°C, A	290/28.5	250/30.0	345/31.5	345/33.8	475/37.8	475/39.0
Duty cycle max. 20°C, A/%/V			400/65/34.0	400/65/36.0	550/60/41.5	550/60/42.0
Duty cycle 100% 40°C, A/V	220/25.0	210/28.4	300/29.0	300/32.0	430/35.5	430/37.2
Duty cycle 60% 40°C, A/V	230/25.5	220/28.8	370/32.5	370/34.8	510/39.5	510/40.4
Duty cycle max. 40°C, A/%/V	300/25/29.0	250/35/30.0	400/50/34.0	400/45/36.0	550/50/41.5	550/50/42.0
Open circuit voltage, V	50-60		65-75		75-80	
² Sphere of application	S/CE		S/CE		S/CE	
³ Protection class	IP23S		IP23		IP23	
Standards, C	IEC60974-1. IEC60974-5. IEC60974-10 Cl. A					
Standards, S	IEC60974-1. IEC60974-10 Cl. A					
Dimensions C (HxWxL), mm	700x260x735		700x260x735		700x260x735	
Dimensions S (HxWxL), mm	454x260x735		454x260x735		454x260x735	
Weight C / S, kg	36.9 / 26		52 / 35		53 / 36	

POWER SOURCE	300 Boost				400 Boost			
Mains voltage $\pm 10\%$ (50-60Hz), V	3x208-380		3x380-440		3x208-380		3x380-440	
Minimum generator size, kVA	16		16		25		25	
¹ Minimum short-circuit power, MVA	1.7		3.75					
Fuse, A	20		16		25-50		25-50	
Mains current effective, A	19.5		10.6		22.0		11.7	
Mains current max., A	31.6		16.2		45.0		23.5	
Power 100%, kVA	7.1		7.0		8.3		8.1	
Power max., kVA	11.0		10.6		16.7		16.3	
Power open circuit, W	45		16		60		56	
Efficiency, %	82		87		84		88	
Power factor	0.95		0.95		0.96		0.95	
	MIG	MMA	MIG	MMA	MIG	MMA	MIG	MMA
Current range, A	15-300	15-250	15-300	15-250	15-400	15-400	15-400	15-400
Duty cycle 100% 20°C, A	250/26.5		250/26.5		300/29.0	300/32.0	300/29.0	300/32.0
Duty cycle max. 20°C, A/%/V	300/40/29.0		300/40/29.0		400/30/34.0	400/30/32.0	400/30/34.0	400/30/32.0
Duty cycle 100% 40°C, A/V	200/24.0	200/28.0	200/24.0	200/28.0	250/26.5	220/28.8	250/26.5	220/28.8
Duty cycle 60% 40°C, A/V	210/24.5	210/28.4	210/24.5	210/28.4	280/28.0	260/30.4	280/28.0	260/30.4
Duty cycle max. 40°C, A/%/V	300/25/29.0	250/35/30.0	300/25/29.0	250/35/30.0	400/25/34.0	400/20/36.0	400/25/34.0	400/20/36.0
Open circuit voltage, V	50-60				70-75			
² Sphere of application	S/CE				S/CE			
³ Protection class	IP23S				IP23			
Standards, C	IEC60974-1. IEC60974-5. IEC60974-10 Cl. A				IEC60974-1. IEC60974-5. IEC60974-10 Cl. A			
Standards, S	IEC60974-1. IEC60974-10 Cl. A				IEC60974-1. IEC60974-10 Cl. A			
Dimensions C (HxWxL), mm	700x260x735				900x260x735			
Dimensions S (HxWxL), mm	454x260x735				654x260x735			
Weight C / S, kg	45 / 34				66 / 49			

- This equipment complies with EN / IEC61000-3-12:2014 (/ 2011) provided that the short-circuit power S_{sc} of the grid at the interface point is greater than or equal to the stated data in the abovementioned table. It is the responsibility of the installer or user of the equipment to ensure, by consultation with the distribution network operator if necessary, that the equipment is connected only to a supply with a short-circuit power S_{sc} greater than or equal to the stated data in the abovementioned table.
- S** This machine meets the demand made for machines which are to operate in areas with increased hazard of electric shocks.
- The machine is designed for indoor and outdoor use according to protection class IP23 / IP23S.
IP23S: The machine may be stored but is not intended to be used outside during precipitation unless sheltered.

Technical data 2

WIRE FEED UNIT MWF	
Wire feed speed, m/min	0.5-30.0
Torch connection	EURO
Wire-reel diameter, mm	300
Wire spool, kg	5-18
Duty cycle 100 % 40°C, A	430
Duty cycle 60% 40°C, A	500
Duty cycle max. 40°C, A/%	550/50
³⁾ Protection class	IP23
Wire diameter, mm	0.6-1.6
Gas pressure, MPa (bar)	0.6 (6.0)
Dimensions (HxWxL), mm	457x260x672.5
Weight, kg	14.0
Standards	IEC60974-5, IEC60974-10 CL. A

COOLING UNIT MCU 1300	
Cooling efficiency (1 l/min), W	1300
Cooling efficiency (1.5 l/min), W	1600
Tank capacity, liter	5
Flow, bar - °C - l/min	3.0-60-1.5
Pressure max., bar	5
Standards	IEC60974-2. IEC60974-10 CL.A
Dimension s (HxWxL), mm	207x260x680
Weight	20

EC DECLARATION OF CONFORMITY



MIGATRONIC A/S
Aggersundvej 33
9690 Fjerritslev
Denmark

hereby declare that our machine as stated below

Type: SIGMA CORE

conforms to directives: 2014/35/EU
2014/30/EU
2011/65/EU

European standards: EN IEC60974-1:2018/A1:2019
EN IEC60974-2:2019
EN IEC60974-5:2019
EN IEC60974-10:2014/A1:2015

Regulation: 2019/1784/EU

Issued in Fjerritslev 01.10.2022

Kristian M. Madsen
CEO

- 1) This equipment complies with EN / IEC61000-3-12:2014 (/ 2011) provided that the short-circuit power S_{sc} of the grid at the interface point is greater than or equal to the stated data in the abovementioned table. It is the responsibility of the installer or user of the equipment to ensure, by consultation with the distribution network operator if necessary, that the equipment is connected only to a supply with a short-circuit power S_{sc} greater than or equal to the stated data in the abovementioned table.
- 2) **S** This machine meets the demand made for machines which are to operate in areas with increased hazard of electric shocks.
- 3) The machine is designed for indoor and outdoor use according to protection class IP23 / IP23S.
IP23S: The machine may be stored but is not intended to be used outside during precipitation unless sheltered.

Anschluss und Inbetriebnahme

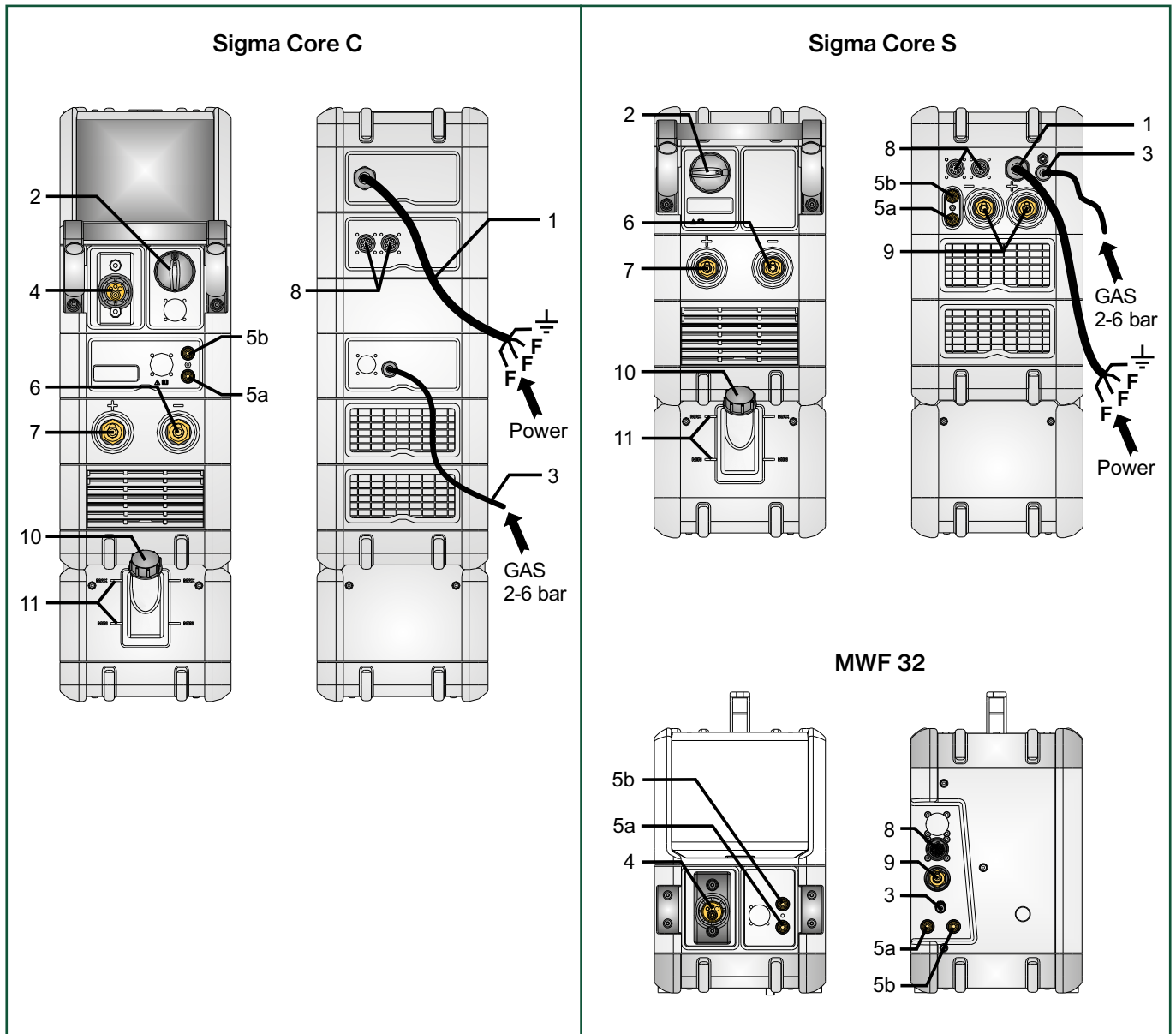

1. Netzanschluss
2. Ein- und Ausschalter on/off
3. Schutzgasanschluss
4. Anschluss - Schweißschlauch
- 5a. Schnellkupplung für Kühlschlauch, Vorlauf (blau)
- 5b. Schnellkupplung für Kühlschlauch, Rücklauf (rot)
6. Anschluss für Masseklemme (MIG) oder Elektrodenhalter (MMA)
7. Anschluss für Masseklemme (MMA) oder Elektrodenhalter (MMA)
8. CAN-Anschluss und MWF-Versorgung
9. Anschluss dem Zwischenschlauchpaket
10. Nachfüllen von Kühlflüssigkeit
11. Ablesen von Kühlflüssigstand (Min/Max)

Anschluss und Inbetriebnahme



Warnung

Lesen Sie die Warnhinweise und Betriebsanleitung sorgfältig vor der Inbetriebnahme und speichern Sie die Information für den späteren Gebrauch.

Zulässige Installation

Netzanschluss

Die Maschine soll an eine Netzspannung angekuppelt werden, die mit den Angaben auf dem Typenschild (U1) hinter die Maschine übereinstimmt.

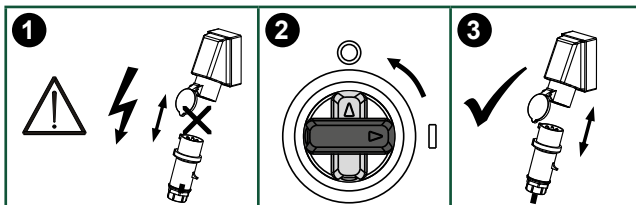
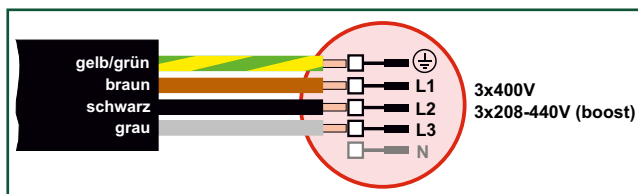

Spannungsstabilisierungs-Kit

Die Stromquelle lässt sich mit einem Spannungsstabilisierungs-Kit zum Schutz gegen höhere Spannungsschwankungen konfigurieren, z.B. beim Generatorbetrieb, wo die Maschine an eine separate Stromversorgung angeschlossen ist.

Schutzgasanschluss

Den Gasschlauch an der Rückseite der Maschine (3) an eine Gasversorgung mit Druckregler (2-6 bar) anschließen. (NB! Einige Druckreglertypen fordern einen höheren Ausgangsdruck als 2 bar um optimal zu funktionieren). Eine Gasflasche/zwei Gasflaschen können hinter dem Wagen fixiert werden.

Gasverbrauch

Abhängig von der Schweißaufgabe, der Gasart und der Schweißnaht variiert der Gasverbrauch in Bereichen von 6 bis 7 l/min bei niedrigen Stromstärken (<25 A) bis zu 27 l/min bei max. Strom.

Materialverbrauch

Materialverbrauch kann berechnet werden, wenn die Schweißzeit in Minuten mit der Drahtfördergeschwindigkeit (m/min) und Gewicht pro Meter der aktuellen Zusatzmaterialien multipliziert werden.

Anschluss des Elektrodenhalters für MMA

Elektrodenhalter und Massekabel werden an Pluspol (10) und Minuspol (8) angeschlossen. Die zu wählende Polarität ist von den zu verwendenden Elektroden abhängig und wird gemäß den Herstellerangaben (siehe Elektroden-Verpackung) gewählt.

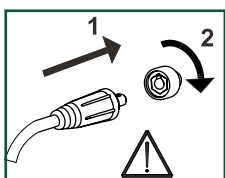

Wichtig!

Achten Sie auf festen Sitz der Anschlüsse von Massekabel und Schweißschlauch. Die Stecker und Kabel können sonst beschädigt werden.

Anschluß des Schweißschlauchs

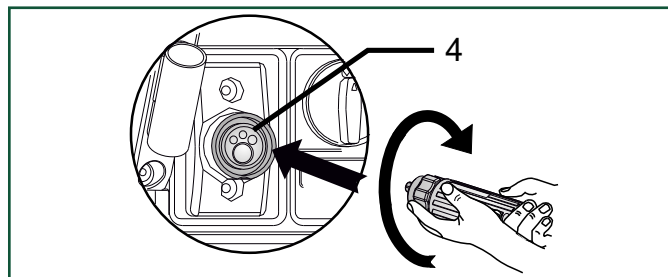

Empfohlene Kabelgrößen

Schweißstrom	DC	PULS
200 A	35 mm ²	35 mm ²
300 A	50 mm ²	70 mm ²
400 A	95 mm ² / 2x50 mm ²	95 mm ² / 2x50 mm ²
550 A	2x70 mm ²	2x70 mm ²

Schweißprozess	Abstand zum Werkstück (a+b)	Gesamtkabellänge im Schweißkreislauf (a+b+c)
MIG - Puls	10 m	20 m
MIG - ohne Puls	30 m	60 m

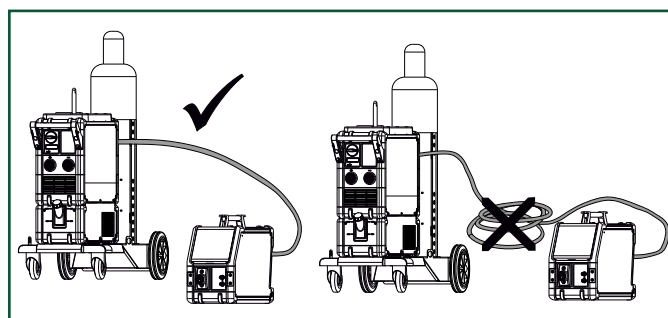
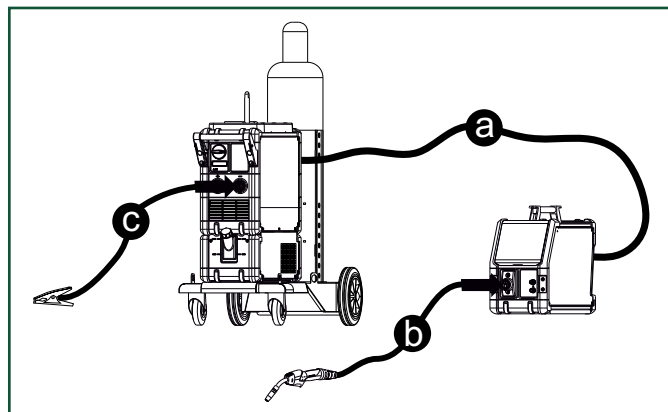

WARNUNG

Bei Betätigung des Brenntasters liegt Spannung an dem Schweißdraht und der Elektrode an.

Anschluss und Inbetriebnahme

Hebeanweisung

Wenn die Maschine angehoben werden soll, muss an den der Abbildung gezeigten Hebepunkten angesetzt werden. Die Maschine darf nicht mit montierter Gasflasche angehoben werden!

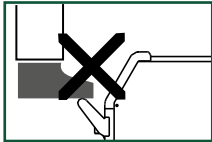
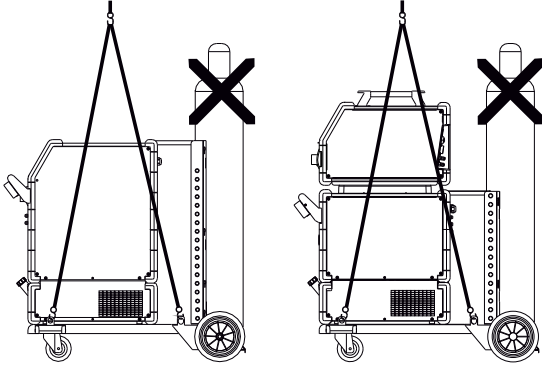

Die Maschine nicht am Handgriff anheben. Nicht auf den Handgriff treten.

Justierung der Drahtbremse

Die Bremse wird so fest eingestellt, daß die Drahtrolle stoppt, ehe der Schweißdraht über die Korbspule springt. Die Bremskraft ist vom Gewicht der Drahtrolle und der Drahtfördergeschwindigkeit abhängig. Werkeinstellung = 15kg.

Justierung:

- Der Drehknopf lässt sich mittels eines dünnen Schraubendrehers herausdrücken und abmontieren.
- Die Drahtbremse durch Festspannen bzw. Lockern der Gegenmutter auf der Achse der Drahtnabe justieren.
- Den Drehknopf wieder montieren.

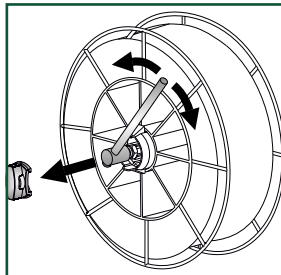

Drahtförderung

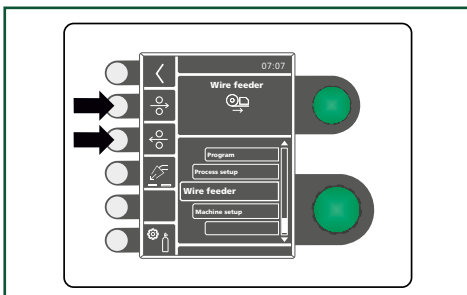
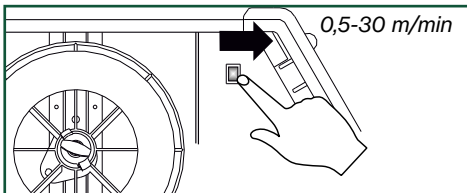

MCU Lüftung

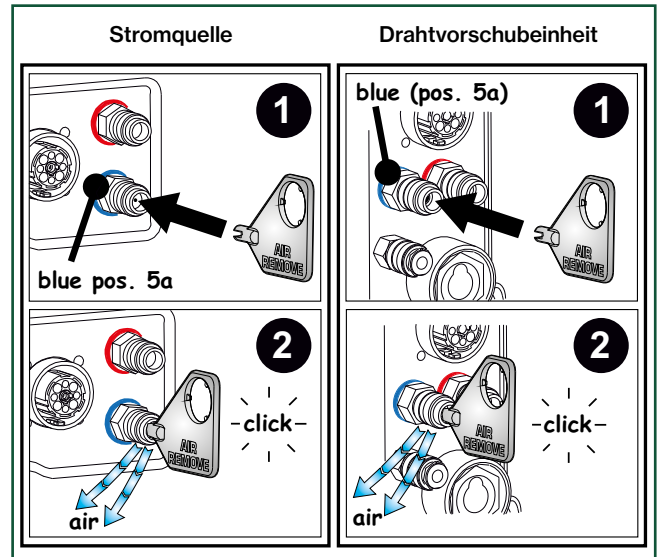

Schloss- und Drehfunktion MWF

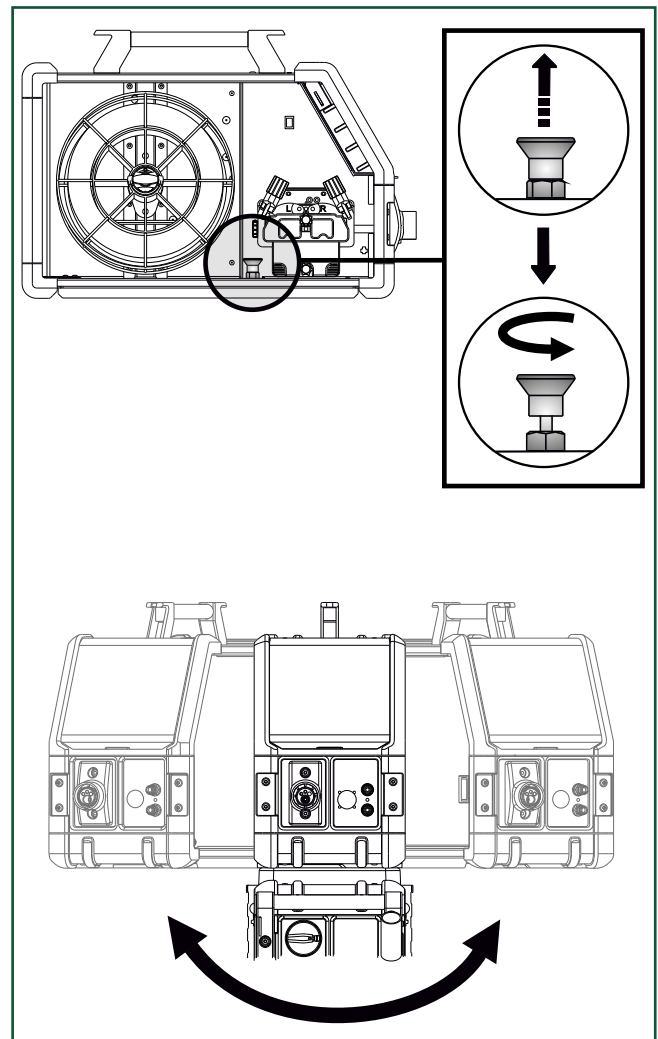

Anschluss und Inbetriebnahme

Montage der Teile in Drahtvorschubeinheit

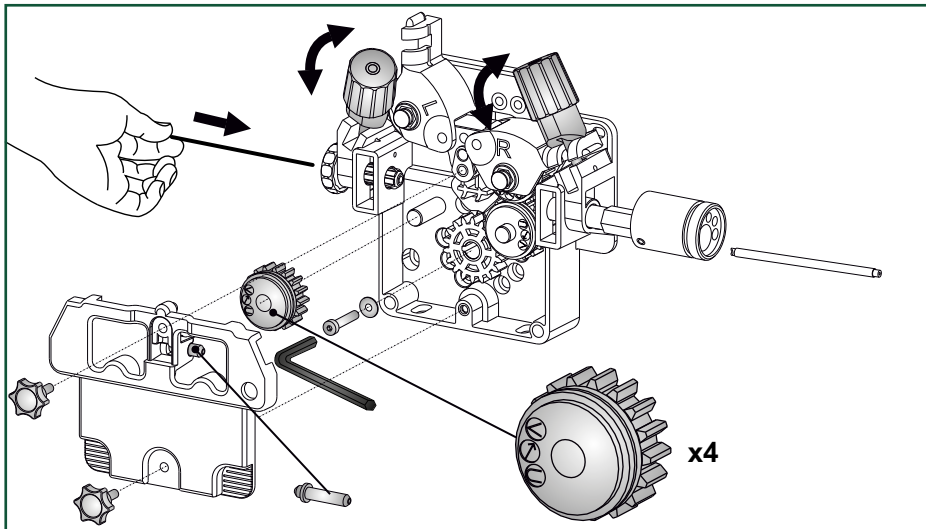

Mit Hilfe der Rändelschraube am Spannbolzen wird der Andruck der Förderrollen so eingestellt, daß eine gleichmässige Förderung des Drahtes gewährleistet ist, ohne den Draht zu deformieren.

Software Einlesen

- Die SD-Karte einlegen.
- Die Maschine einschalten.
- Warten bis die Maschine anzeigt, dass die Aktualisierung abgeschlossen ist.
- Die Maschine ausschalten und die SD-Karte entfernen.
- Die Maschine ist nun einsatzbereit.

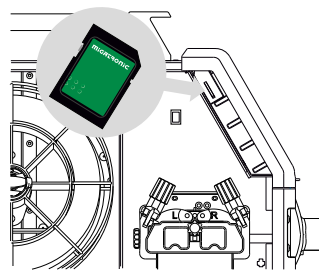

Neue Software wird in Stromquelle und alle anderen angeschlossenen Einheiten eingelesen.

Die Software kann auf <http://migatronik.com> auf eine SD-Karte heruntergeladen werden. Die Dateisystem der SD-Karte muss auf FAT32 formatiert sein.

WICHTIG:

Die Software in der Mappenstruktur //MIGA_SW/SIGMA/ speichern.

Sonderfunktionen

Software/Lizenzen

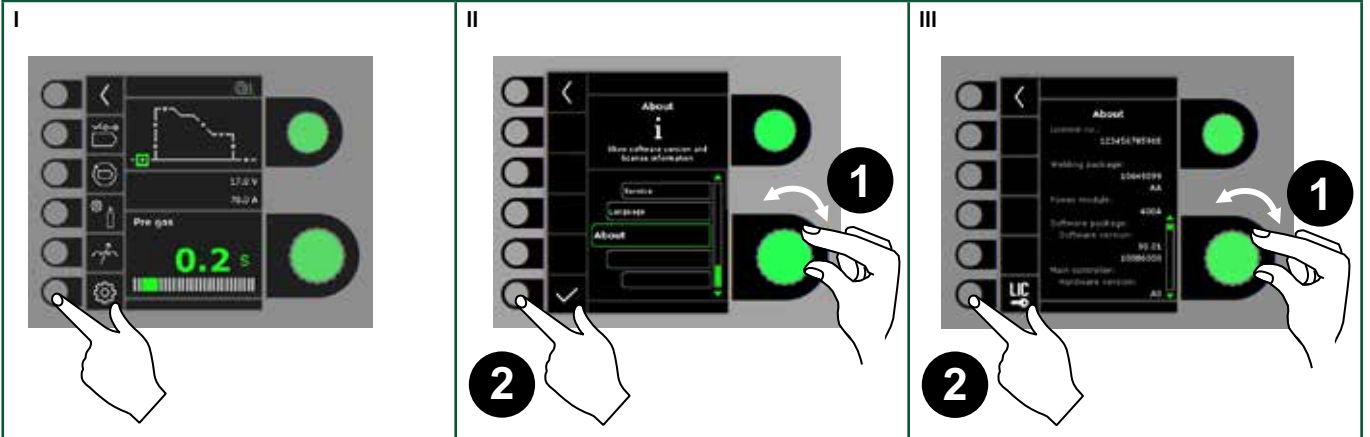

Kabelkompensation (Kalibrierung des Widerstandes im Schweißbrenner)

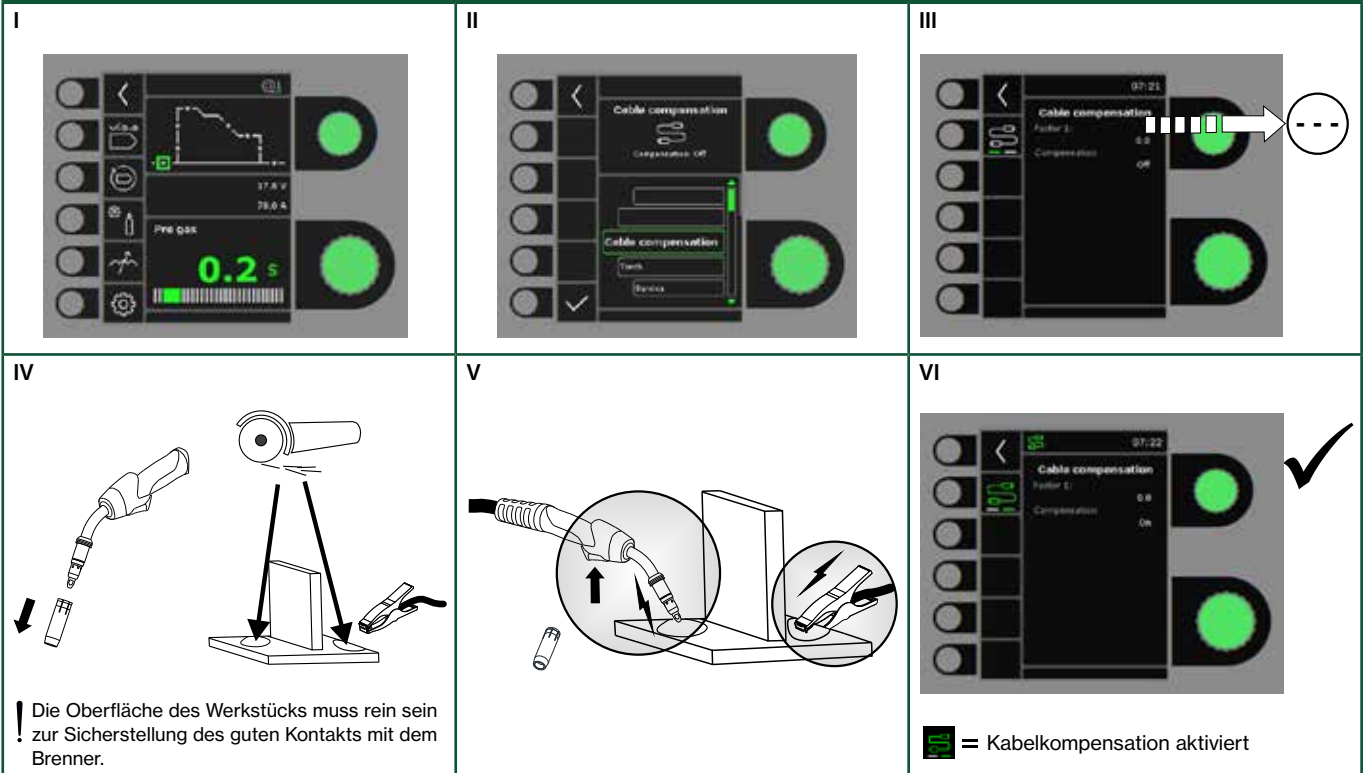

Sonderfunktionen

Kalibrierung des Gasdurchflusses (nicht alle Modelle)

<p>I</p>	<p>II</p>	<p>III</p>
<p>IV</p>	<p>V</p>	

Einstellung des Schweißbrenners

<p>I</p>	<p>II</p>	<p>III</p>
<p>IV</p>		

Fehlerhandhabung

Die SIGMA CORE hat ein fortschrittliches Selbstschutz-System. Die Maschine automatisch stoppt die Gaszufuhr, unterbricht den Schweißstrom und stoppt die Drahtzuführung, wenn ein Fehler auftritt.

Ausgewählte Fehler:



Kühlungsfehler

Kühlungsfehler wird angezeigt auf Geräte, falls der Kühlkreislauf unterbrochen oder der Kühlmitteldurchfluss zu gering ist. Kontrollieren Sie bitte, dass die Kühleinheit korrekt angeschlossen ist und der Wasserbehälter ausreichend gefüllt ist. Überprüfen Sie den Schweißbrenner und die Wasserkühlanschlüsse. Durch kurzes Drücken auf die ✓-Taste wird der Kühlungsfehler abgemeldet.

Gas Fehler (IGC)

Die Gasmenge ist zu gering oder zu groß. Kontrollieren Sie bitte, dass die Gaszufuhr höher als 2 bar und weniger als 6 bar ist, d.h. zwischen 5 l/min und 27 l/min. Gasfehler wird außer Tätigkeit gesetzt, wenn der manuelle Gasfluß zu 27 l/min eingestellt wird. Der Gasfehler wird durch kurzes Drücken auf die ✓-Taste abgemeldet.

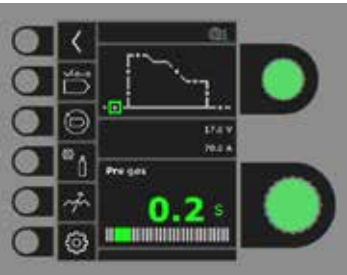
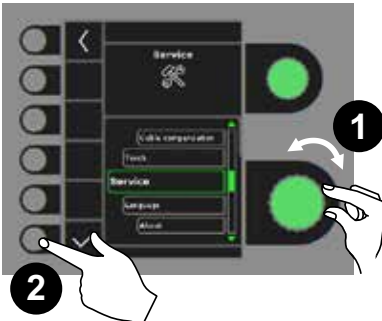
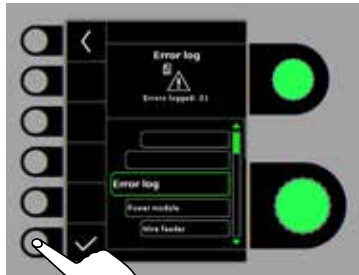
Achtung: Es ist wichtig, dass die angegebene Gaszufuhr während des Schweißens aufrechterhalten werden kann.

Fehlerliste		
<p>I</p> 	<p>II</p> 	<p>III</p> 
<p>IV</p> <p>Fehlerliste Alle Fehler sind in der Maschine im Menü Service gespeichert. Die Fehlerliste kann durch Einsetzen einer SD-Karte und Drücken der folgenden Taste kopiert werden. Die Fehlerliste ist dann auf der SD-Karte gespeichert. Die Fehlerliste kann durch Drücken der Taste mit dem Mülleimer gelöscht werden.</p>		

Technische Daten 1

STROMQUELLE	300		400		550	
Netzspannung $\pm 15\%$ (50-60Hz), V	3x400		3x400		3x400	
Mindestgröße des Generators, kVA	16		27		40	
¹ Minimum Kurzschlussleistung, MVA	3,7		6,0		9,5	
Sicherung, A	16		20		35	
Effektiver Netzstrom, A	10,5		17,5		27,2	
Max. Netzstrom, A	15,4		26,0		39,2	
Leistung 100%, kVA	9,0		12,1		18,9	
Leistung max., kVA	10,7		18,0		27,1	
Leistung Leerlauf, W	11		12		12	
Wirkungsgrad, %	87		89		90	
Leistungsfaktor	0,90		0,90		0,90	
	MIG	MMA	MIG	MMA	MIG	MMA
Strombereich, A	15-300	15-250	15-400	15-400	15-550	15-550
Zulässige ED 100% 20°C, A	290/28,5	250/30,0	345/31,5	345/33,8	475/37,8	475/39,0
Zulässige ED max. 20°C, A/%V			400/65/34,0	400/65/36,0	550/60/41,5	550/60/42,0
Zulässige ED 100% 40°C, A/V	220/25,0	210/28,4	300/29,0	300/32,0	430/35,5	430/37,2
Zulässige ED 60% 40°C, A/V	230/25,5	220/28,8	370/32,5	370/34,8	510/39,5	510/40,4
Zulässige ED max. 40°C, A/%V	300/25/29,0	250/35/30,0	400/50/34,0	400/45/36,0	550/50/41,5	550/50/42,0
Leerlaufspannung, V	50-60		65-75		75-80	
² Anwendungsklasse	S/CE		S/CE		S/CE	
³ Schutzklasse	IP23S		IP23		IP23	
Norm, C Norm, S	IEC60974-1, IEC60974-5, IEC60974-10 Cl. A IEC60974-1, IEC60974-10 Cl. A					
Maße C (HxBxL), mm	700x260x735		700x260x735		700x260x735	
Maße S (HxBxL), mm	454x260x735		454x260x735		454x260x735	
Gewicht C / S, kg	36,9 / 26		52 / 35		53 / 36	

STROMQUELLE	300 Boost				400 Boost			
Netzspannung $\pm 10\%$ (50-60Hz), V	3x208-380		3x380-440		3x208-380		3x380-440	
Mindestgröße des Generators, kVA	16		16		25		25	
¹ Minimum Kurzschlussleistung, MVA	1,7		3,75					
Sicherung, A	20		16		25-50		25-50	
Effektiver Netzstrom, A	19,5		10,6		22,0		11,7	
Max. Netzstrom, A	31,6		16,2		45,0		23,5	
Leistung 100%, kVA	7,1		7,0		8,3		8,1	
Leistung max., kVA	11,0		10,6		16,7		16,3	
Leistung Leerlauf, W	45		16		60		56	
Wirkungsgrad, %	82		87		84		88	
Leistungsfaktor	0,95		0,95		0,96		0,95	
	MIG	MMA	MIG	MMA	MIG	MMA	MIG	MMA
Strombereich, A	15-300	15-250	15-300	15-250	15-400	15-400	15-400	15-400
Zulässige ED 100% 20°C, A	250/26,5		250/26,5		300/29,0	300/32,0	300/29,0	300/32,0
Zulässige ED max. 20°C, A/%V	300/40/29,0		300/40/29,0		400/30/34,0	400/30/32,0	400/30/34,0	400/30/32,0
Zulässige ED 100% 40°C, A/V	200/24,0	200/28,0	200/24,0	200/28,0	250/26,5	220/28,8	250/26,5	220/28,8
Zulässige ED 60% 40°C, A/V	210/24,5	210/28,4	210/24,5	210/28,4	280/28,0	260/30,4	280/28,0	260/30,4
Zulässige ED max. 40°C, A/%V	300/25/29,0	250/35/30,0	300/25/29,0	250/35/30,0	400/25/34,0	400/20/36,0	400/25/34,0	400/20/36,0
Leerlaufspannung, V	50-60				70-75			
² Anwendungsklasse	S/CE				S/CE			
³ Schutzklasse	IP23S				IP23			
Norm, C Norm, S	IEC60974-1, IEC60974-5, IEC60974-10 Cl. A IEC60974-1, IEC60974-10 Cl. A				IEC60974-1, IEC60974-5, IEC60974-10 Cl. A IEC60974-1, IEC60974-10 Cl. A			
Maße C (HxBxL), mm	700x260x735				900x260x735			
Maße S (HxBxL), mm	454x260x735				654x260x735			
Gewicht C / S, kg	45 / 34				66 / 49			

- Dieses Gerät entspricht den EN / IEC61000-3-12:2014 (/ 2011), sofern die Kurzschlussleistung S_{sc} der Netzversorgung am Netzstecker größer als oder gleich der angegebenen Daten im obenerwähnten Schema ist. Es ist die Verantwortung des Elektroinstallateurs oder der Anwender des Gerätes zu gewährleisten, eventuell durch Rücksprache mit dem Netzbetreiber, dass das Gerät nur an eine Stromversorgung mit Kurzschlussleistung S_{sc} größer als oder gleich wie der angegebenen Daten im obenerwähnten Schema angeschlossen ist.
- S** Erfüllt die Anforderungen an Geräte zur Anwendung unter erhöhter elektrischer Gefährdung
- Die Maschine ist für den Innen- und Außenbereich gemäß der Schutzklasse IP23 / IP23S ausgelegt.
IP23S: Die Maschine kann gelagert werden, darf jedoch nicht während eines Niederschlags im Freien verwendet werden. Es sei denn, sie wird dagegen geschützt.

Technische Daten 2

DRAHTVORSCHUBEINHEIT MWF	
Drahtfördergeschwindigkeit, m/min	0,5-30,0
Brenneranschluss	EURO
Drahtspulendurchmesser, mm	300
Drahtspule, kg	5-18
Zulässige ED 100% 40°C, A/%	430
Zulässige ED 60% 40°C, A/%	500
Zulässige ED max. 40°C, A/%	550/50
³⁾ Schutzklasse	IP23
Drahtdurchmesser, mm	0,6-1,6
Gasdruck, MPa (bar)	0,6 (6,0)
Maße (HxBxL), mm	457x260x672,5
Gewicht, kg	14,0
Norm	IEC60974-5, IEC60974-10 CL. A

KÜHLEINHEIT MCU 1300	
Kühlleistung (1 l/min), W	1300
Kühlleistung (1,5 l/min), W	1600
Tankkapazität, liter	5
Durchflussmenge, bar - °C - l/min	3,0-60-1,5
Druck max., bar	5
Norm	IEC60974-2, IEC60974-10 CL.A
Maße (HxBxL), mm	207x260x680
Gewicht	20

EU-KONFORMITÄTSERKLÄRUNG



MIGATRONIC A/S
Aggersundvej 33
9690 Fjerritslev
Dänemark

erklärt, dass das unten erwähnte Gerät

Typ: SIGMA CORE

den Bestimmungen der EU-Richtlinien
2014/35/EU
2014/30/EU
2011/65/EU entspricht

Europäische Normen: EN IEC60974-1:2018/A1:2019
EN IEC60974-2:2019
EN IEC60974-5:2019
EN IEC60974-10:2014/A1:2015

Verordnung: 2019/1784/EU

Ausgestellt in Fjerritslev am 01.10.2022

Kristian M. Madsen
CEO

- 1) Dieses Gerät entspricht den EN / IEC61000-3-12:2014 (/ 2011), sofern die Kurzschlussleistung S_{sc} der Netzversorgung am Netzstecker größer als oder gleich der angegebenen Daten im obenerwähnten Schema ist. Es ist die Verantwortung des Elektroinstallateurs oder der Anwender des Gerätes zu gewährleisten, eventuell durch Rücksprache mit dem Netzbetreiber, dass das Gerät nur an eine Stromversorgung mit Kurzschlussleistung S_{sc} größer als oder gleich wie der angegebenen Daten im obenerwähnten Schema angeschlossen ist.
- 2) **S** Erfüllt die Anforderungen an Geräte zur Anwendung unter erhöhter elektrischer Gefährdung
- 3) Die Maschine ist für den Innen- und Außenbereich gemäß der Schutzklasse IP23 / IP23S ausgelegt.
IP23S: Die Maschine kann gelagert werden, darf jedoch nicht während eines Niederschlags im Freien verwendet werden. Es sei denn, sie wird dagegen geschützt.

Branchement et fonctionnement

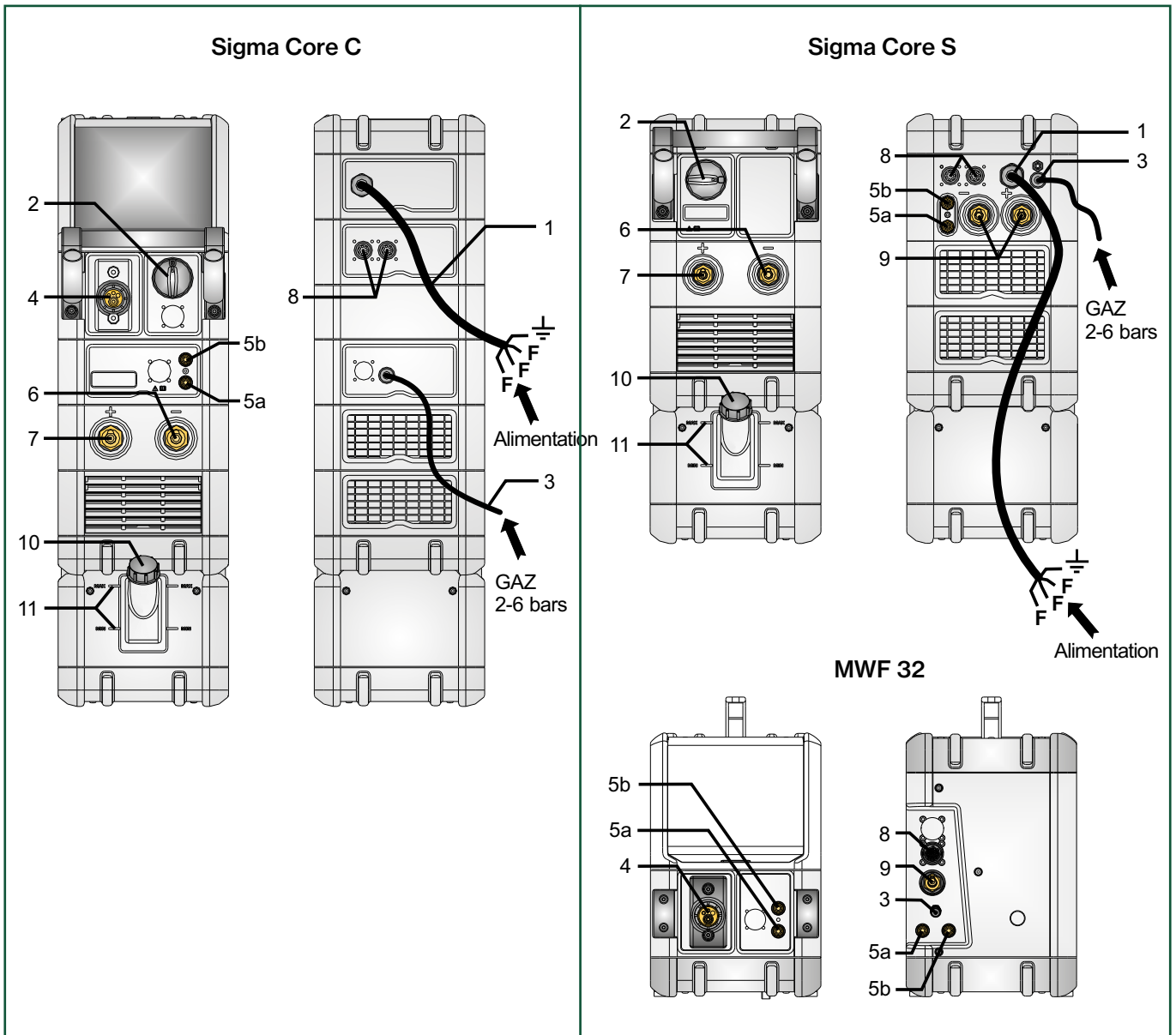

1. Raccordement électrique
2. Interrupteur d'alimentation
3. Raccordement au gaz de protection
4. Raccordement de la torche de soudage
- 5a. Raccordement de tuyau du système de refroidissement, arrivée (bleu)
- 5b. Raccordement de tuyau du système de refroidissement, retour (rouge)
6. Raccordement de la pince de mise à la terre (MIG) ou du porte-électrode (MMA)
7. Raccordement de la pince de mise à la terre (MMA) ou du porte-électrode (MMA)
8. Raccordement CAN et alimentation MWF
9. Raccordement câble intermédiaire
10. Remplissage du liquide de refroidissement
11. Niveau du liquide de refroidissement (Min/Max)

Branchement et fonctionnement



Attention

Lisez attentivement la fiche de mise en garde/le mode d'emploi avant la première utilisation et conservez ces informations en vue de leur utilisation ultérieure.

Installation autorisée

Raccordement électrique

Branchez la machine à une prise secteur adaptée.

Veuillez lire la plaque signalétique (U.) à l'arrière de la machine.

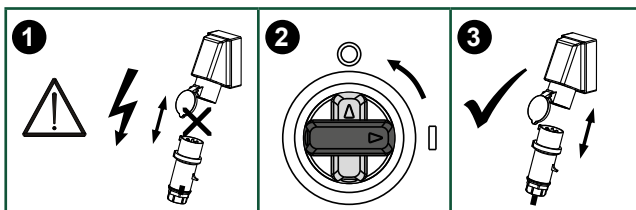
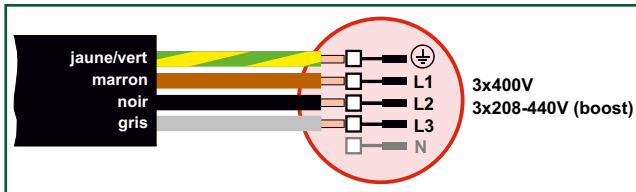

Kit de stabilisation de la tension

La source d'alimentation est configurable avec un kit de stabilisation de la tension ; celui-ci prévient les variations de tension plus importantes. Par exemple : en cas d'utilisation du générateur et lorsque la machine est branchée à une alimentation séparée.

Raccordement au gaz de protection

Raccorder le tuyau de gaz qui se trouve sur le panneau arrière de la machine (3) et le relier à une alimentation en gaz avec régulateur de pression (2-6 bars). (Remarque : pour une utilisation optimale, certains types de régulateurs de pression nécessitent une pression de sortie supérieure à 2 bars).

Une/deux bouteilles de gaz peuvent être installées à l'arrière du chariot.

Consommation de gaz

Selon la tâche de soudage, le type de gaz et la conception de la soudure, la consommation de gaz varie entre 6 et 7 l/min à faible ampérage (<25A) et jusqu'à 27 l/min au maximum.

Consommation de matériaux

La consommation de matériaux peut être estimée en calculant le temps de soudage en minutes multiplié par la vitesse d'alimentation du fil (m/min) multiplié par le poids par mètre des consommables de soudure utilisés.

Branchement du porte-électrode pour le soudage MMA

Le porte-électrode et le câble de mise à la terre sont branchés sur la borne plus (10) et la borne moins (8). Respectez les instructions relatives à la polarité indiquées par le fournisseur des électrodes.

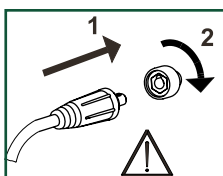

Important !

Afin d'éviter la destruction des prises et câbles, assurez-vous que le contact électrique est bien établi lors du branchement des câbles de mise à la terre et des torches de soudage à la machine.

Raccordement de la torche de soudage

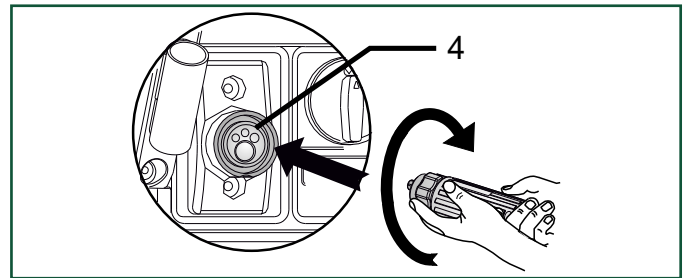

Dimensions de câble recommandées

Courant de soudage	Courant Continu	Pulsé
200 A	35 mm ²	35 mm ²
300 A	50 mm ²	70 mm ²
400 A	95 mm ² / 2x50 mm ²	95 mm ² / 2x50 mm ²
550 A	2x70 mm ²	2x70 mm ²

Procédé de soudage	Distance par rapport à la pièce (a+b)	Longueur totale du câble dans le circuit de soudage (a+b+c)
MIG - pulsé	10 m	20 m
MIG - non pulsé	30 m	60 m

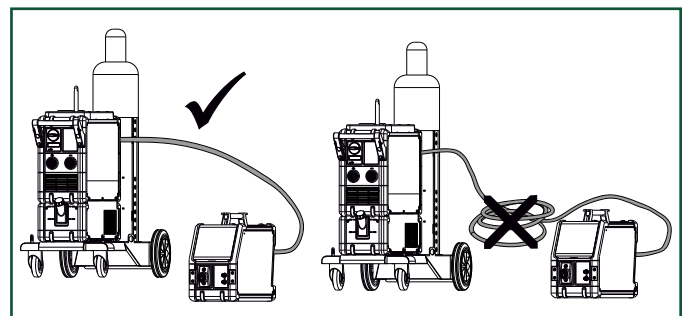
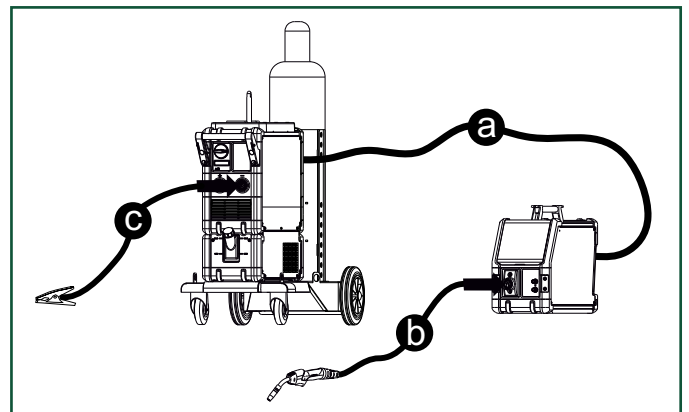

Attention

L'activation de la gâchette de la torche génère une tension au niveau du fil de soudage/de l'électrode.

Branchement et fonctionnement

Instructions de levage

Veillez à respecter les points de levage indiqués (voir figure) lors du levage de la machine. Il est important de retirer les bouteilles de gaz avant de procéder au levage de la machine, le cas échéant.

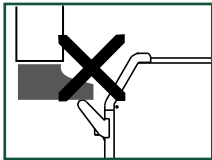
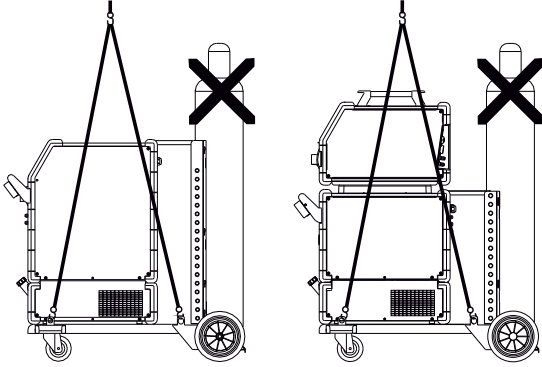

Ne pas soulever la machine par la poignée.
Ne pas marcher sur la poignée.

Réglage du frein du dévidoir

Le frein doit être réglé de sorte que le système de dévidage s'arrête avant que le fil de soudage n'avance au-delà de l'extrémité de la bobine. Le degré de freinage dépend du poids de la bobine et de la vitesse de dévidage.

La valeur par défaut est de 15 kg.

Réglage :

- Démontez le bouton de réglage en plaçant un petit tournevis derrière le bouton, puis sortez ce dernier.
- Régler le frein en serrant ou desserrant l'écrou autobloquant au niveau de l'axe du moyeu.
- Réinstaller le bouton.

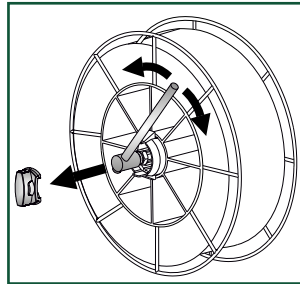

Avance pas à pas du fil

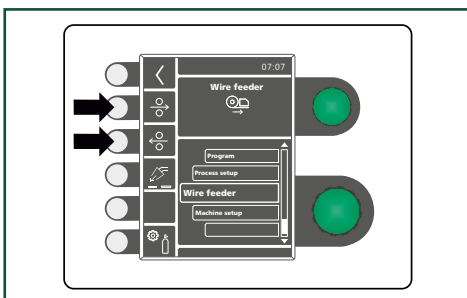
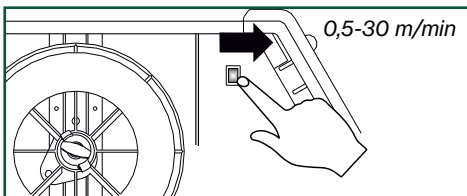

Ventilation MCU

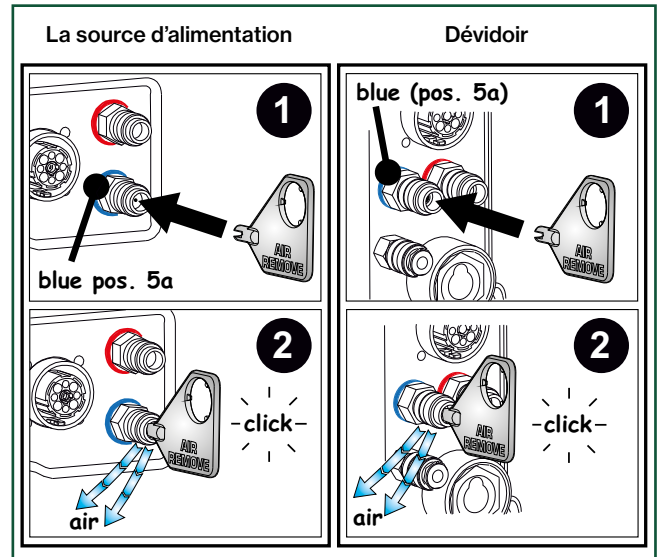

Fonction de pivotement du MWF

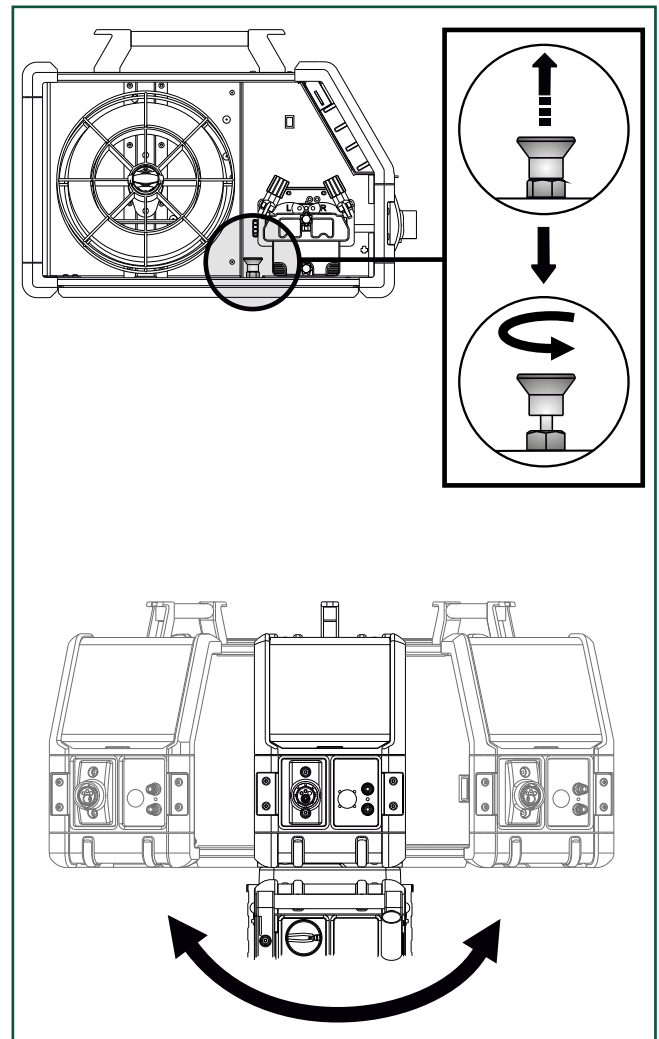

Branchement et fonctionnement

Assemblage des pièces dans le dévidoir

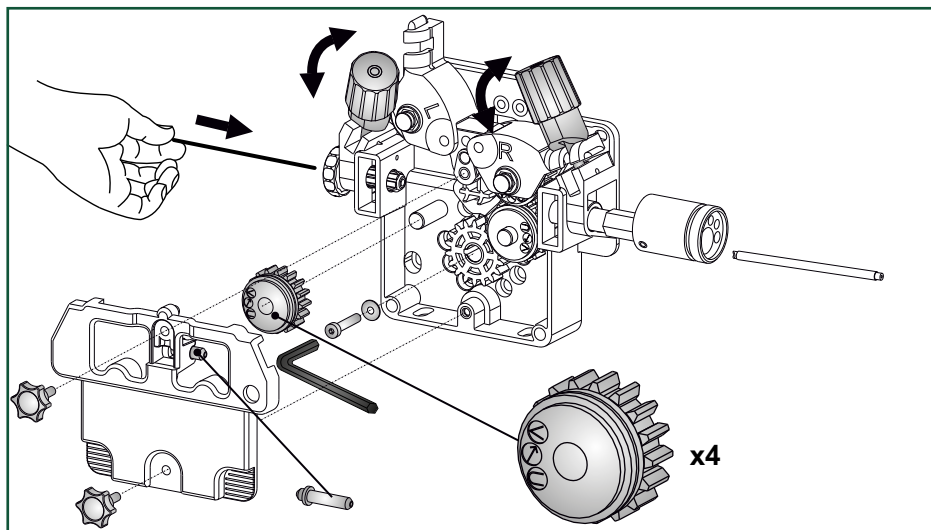

Le réglage de la pression sur le galet doit permettre l'arrêt du fil au niveau du tube de contact

Mise à jour du logiciel

- Insérer la carte SD
- Démarrer la machine
- Patienter jusqu'à ce que la machine indique la fin de la mise à jour.
- Éteindre la machine et retirer la carte SD.
- La machine est désormais prête à l'emploi.

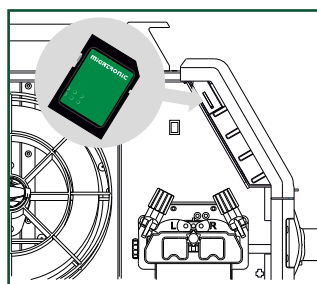

Le nouveau logiciel est alors chargé dans le module d'alimentation ainsi que dans tous les dispositifs raccordés à la machine.

Vous pouvez télécharger le logiciel à l'adresse suivante <http://migatron.com> sur une carte SD. Le système de fichiers de la carte SD doit être formaté en FAT32.

IMPORTANT :

Enregistrez le Software dans le //MIGA_SW/SIGMA/ file structure.

Fonctions spéciales

Logiciel/licences

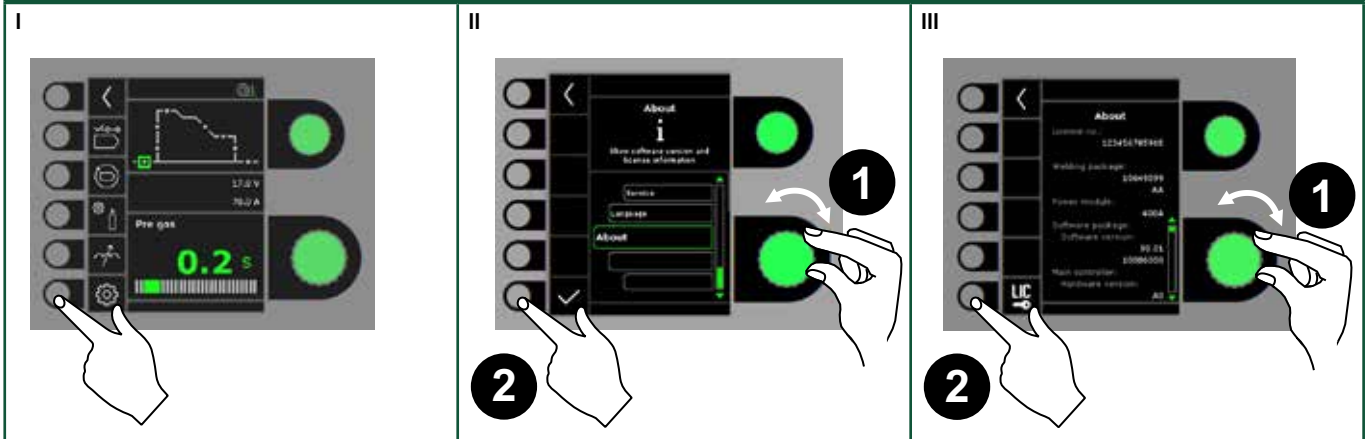

Compensation de câble (étalonnage de la résistance dans la torche de soudage)

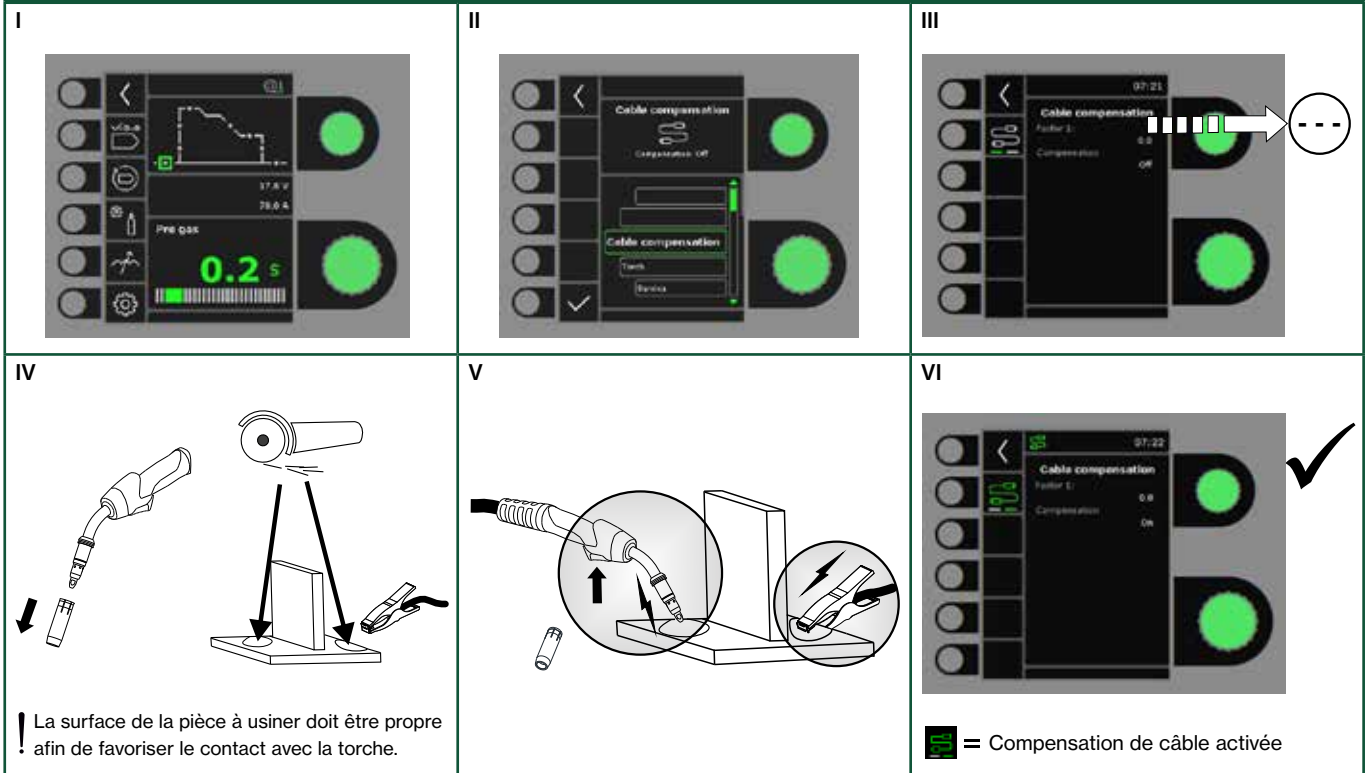

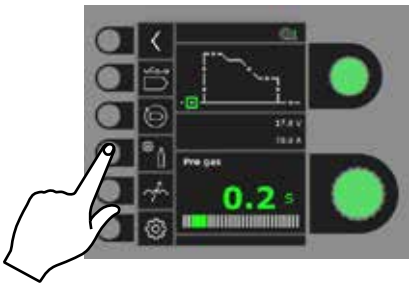
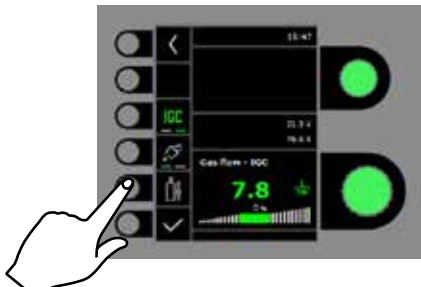
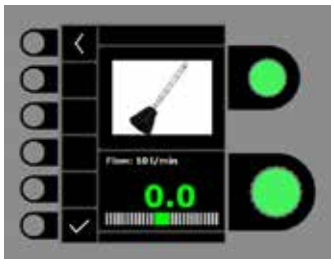
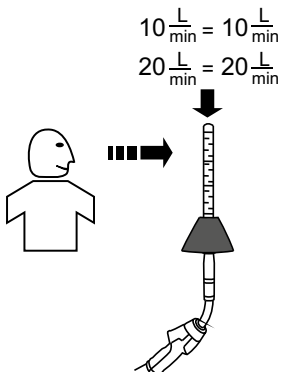
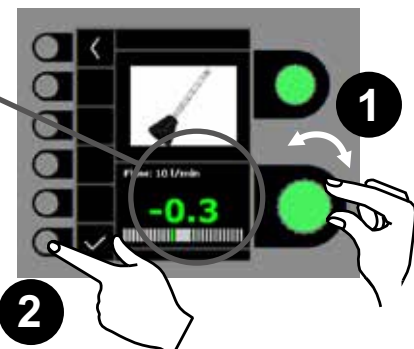

Fonctions spéciales

Réglage du débit de gaz (sur certains modèles uniquement)

<p>I</p> 	<p>II</p> 	<p>III</p> 
<p>IV</p> 	<p>V</p> 	

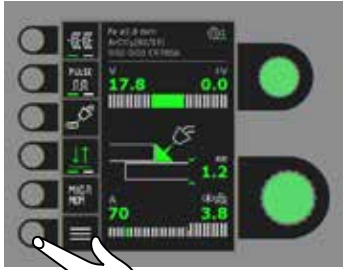
Réglage de la torche

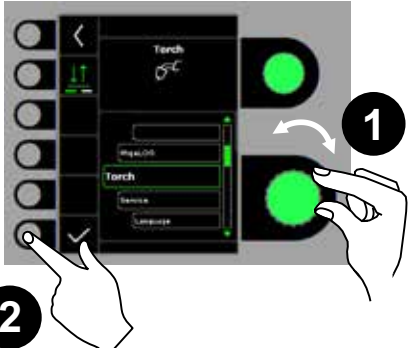
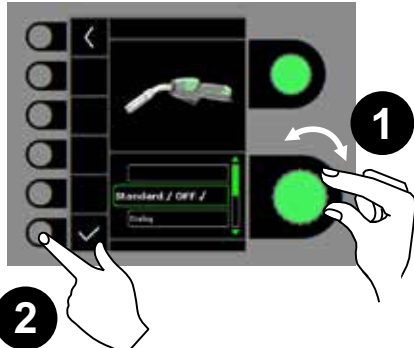
<p>I</p> 	<p>II</p> 	<p>III</p> 
<p>IV</p> 		

Traitement des erreurs

SIGMA CORE dispose d'un système d'autoprotection intégré sophistiqué. La machine coupe automatiquement l'alimentation en gaz, le courant de soudage et le dévidage du fil en cas d'erreur.

Exemples d'erreurs :

Défaut refroidissement torche



Un défaut de refroidissement est signalé lorsque le volume de liquide de refroidissement en circulation est insuffisant, en raison d'un problème de raccordement, de pièces défectueuses ou d'une obstruction.

Contrôler si les tuyaux du système de refroidissement sont correctement branchés, compléter le niveau d'eau du réservoir et vérifier la torche de soudage et les branchements. Cette erreur peut être annulée par une pression brève sur la touche ✓.

Erreur de gaz (IGC)

L'erreur de gaz est due à un débit trop grand ou trop faible. S'assurer que le débit de gaz est supérieur à 2 bars et inférieur à 6 bars, soit l'équivalent de 5 l/min et de 27 l/min. Cette erreur peut être résolue en réglant le débit de gaz à 27 l/min et annulée en appuyant brièvement sur la touche ✓.

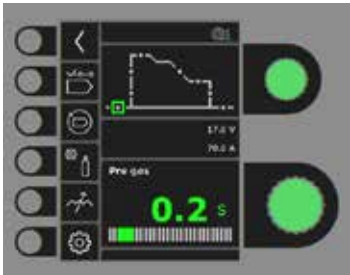
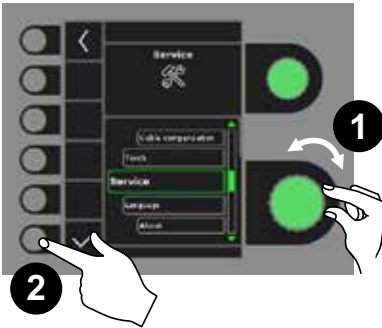
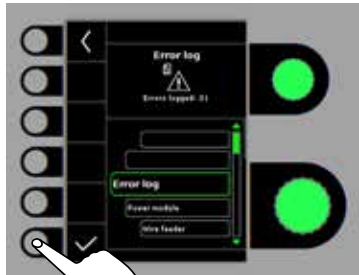
Remarque : il est important que l'alimentation en gaz indiquée puisse être maintenue pendant le soudage.

Journal des erreurs		
<p>I</p> 	<p>II</p> 	<p>III</p> 
<p>IV</p> <p>Journal des erreurs</p> <p>Toutes les erreurs sont enregistrées dans un journal accessible dans le menu Service. Le journal des erreurs peut être diffusé en insérant une carte SD et en appuyant sur la touche suivante : Le journal des erreurs est alors enregistré sur la carte SD. Le contenu du journal peut être effacé par une pression sur la touche de suppression (icône représentant une poubelle).</p>		

Caracteristiques techniques 1

MODULE d'ALIMENTATION	300		400		550	
Tension de secteur $\pm 15\%$ (50-60Hz), V	3x400		3x400		3x400	
Taille minimale du générateur, kVA	16		27		40	
¹ Puissance de court-circuit minimale Ssc, MVA	3,7		6,0		9,5	
Fusible, A	16		20		35	
Courant secteur efficace, A	10,5		17,5		27,2	
Courant secteur max., A	15,4		26,0		39,2	
Puissance nominale, kVA	9,0		12,1		18,9	
Puissance max., kVA	10,7		18,0		27,1	
Puissance circuit ouvert, W	11		12		12	
Rendement, %	87		89		90	
Facteur de puissance	0,90		0,90		0,90	
	MIG	MMA	MIG	MMA	MIG	MMA
Plage du courant, A	15-300	15-250	15-400	15-400	15-550	15-550
Facteur de marche 100% 20°C, A	290/28,5	250/30,0	345/31,5	345/33,8	475/37,8	475/39,0
Facteur de marche max. 20°C, A/%/V			400/65/34,0	400/65/36,0	550/60/41,5	550/60/42,0
Facteur de marche 100% 40°C, A/V	220/25,0	210/28,4	300/29,0	300/32,0	430/35,5	430/37,2
Facteur de marche 60% 40°C, A/V	230/25,5	220/28,8	370/32,5	370/34,8	510/39,5	510/40,4
Facteur de marche max. 40°C, A/%/V	300/25/29,0	250/35/30,0	400/50/34,0	400/45/36,0	550/50/41,5	550/50/42,0
Tension à vide, V	50-60		65-75		75-80	
² Classe d'utilisation	S/CE		S/CE		S/CE	
³ Classe de protection	IP23S		IP23		IP23	
Normes, C	IEC60974-1, IEC60974-5, IEC60974-10 Cl. A					
Normes, S	IEC60974-1, IEC60974-10 Cl. A					
Dimensions C (hxlaxlo), mm	700x260x735		700x260x735		700x260x735	
Dimensions S (hxlaxlo), mm	454x260x735		454x260x735		454x260x735	
Poids C / S, kg	36,9 / 26		52 / 35		53 / 36	

MODULE d'ALIMENTATION	300 Boost				400 Boost			
Tension de secteur $\pm 10\%$ (50-60Hz), V	3x208-380		3x380-440		3x208-380		3x380-440	
Taille minimale du générateur, kVA	16		16		25		25	
¹ Puissance de court-circuit minimale Ssc, MVA	1,7		3,75					
Fusible, A	20		16		25-50		25-50	
Courant secteur efficace, A	19,5		10,6		22,0		11,7	
Courant secteur max., A	31,6		16,2		45,0		23,5	
Puissance nominale, kVA	7,1		7,0		8,3		8,1	
Puissance max., kVA	11,0		10,6		16,7		16,3	
Puissance circuit ouvert, W	45		16		60		56	
Rendement, %	82		87		84		88	
Facteur de puissance	0,95		0,95		0,96		0,95	
	MIG	MMA	MIG	MMA	MIG	MMA	MIG	MMA
Plage du courant, A	15-300	15-250	15-300	15-250	15-400	15-400	15-400	15-400
Facteur de marche 100% 20°C, A	250/26,5		250/26,5		300/29,0	300/32,0	300/29,0	300/32,0
Facteur de marche max. 20°C, A/%/V	300/40/29,0		300/40/29,0		400/30/34,0	400/30/32,0	400/30/34,0	400/30/32,0
Facteur de marche 100% 40°C, A/V	200/24,0	200/28,0	200/24,0	200/28,0	250/26,5	220/28,8	250/26,5	220/28,8
Facteur de marche 60% 40°C, A/V	210/24,5	210/28,4	210/24,5	210/28,4	280/28,0	260/30,4	280/28,0	260/30,4
Facteur de marche max. 40°C, A/%/V	300/25/29,0	250/35/30,0	300/25/29,0	250/35/30,0	400/25/34,0	400/20/36,0	400/25/34,0	400/20/36,0
Tension à vide, V	50-60				70-75			
² Classe d'utilisation	S/CE				S/CE			
³ Classe de protection	IP23S				IP23			
Normes, C	IEC60974-1, IEC60974-5, IEC60974-10 Cl. A				IEC60974-1, IEC60974-5, IEC60974-10 Cl. A			
Normes, S	IEC60974-1, IEC60974-10 Cl. A				IEC60974-1, IEC60974-10 Cl. A			
Dimensions C (hxlaxlo), mm	700x260x735				900x260x735			
Dimensions S (hxlaxlo), mm	454x260x735				654x260x735			
Poids C / S, kg	45 / 34				66 / 49			

- Cet équipement est conforme à la norme EN / IEC61000-3-12:2014 (/ 2011), à condition que la puissance de court-circuit Ssc du réseau au point de service soit supérieure ou égale aux données figurant dans le tableau ci-dessus. Il incombe à l'installateur ou à l'utilisateur de l'équipement de vérifier, en consultant l'opérateur du réseau de distribution si nécessaire, que la puissance de court-circuit Ssc délivrée est supérieure ou égale aux données figurant dans le tableau ci-dessus.
- S** Cette machine est conforme aux normes exigées pour les machines fonctionnant dans des zones à risque élevé de choc électrique.
- La machine est conçue pour une utilisation intérieure et extérieure selon les classes de protection IP23 et IP23S.
IP23S : La machine peut être entreposée mais n'est pas destinée à être utilisée à l'extérieur pendant les précipitations à moins d'être abritée

Caracteristiques techniques 2

DÉVIDOIR MWF	
Vitesse de dévidage, m/min	0,5-30,0
Raccord de la torche	EURO
Diamètre bobine, mm	300
Bobine, kg	5-18
Facteur de marche 100 % 40°C, A	430
Facteur de marche 60% 40°C, A	500
Facteur de marche max. 40°C, A/%	550/50
Classe de protection	IP23
Diamètre de fil, mm	0,6-1,6
Pression du gaz, MPa (bar)	0,6 (6,0)
Dimensions (hxlaxlo), mm	457x260x672,5
Poids, kg	14,0
Normes	IEC60974-5, IEC60974-10 CL. A

MODULE DE REFROIDISSEMENT MCU 1300	
Capacité de refroidissement (1 l/min), W	1300
Capacité de refroidissement (1,5 l/min), W	1600
Contenance du réservoir, litres	5
Débit, bar - °C - l/min	3,0-60-1,5
Pression max., bar	5
Normes	IEC60974-2, IEC60974-10 CL.A
Dimensions (hxlaxlo), mm	207x260x680
Poids	20

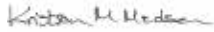
CERTIFICAT DE CONFORMITE CE	
	
MIGATRONIC A/S Aggersundvej 33 9690 Fjerritslev Danemark	
déclarons par la présente que notre machine portant les références ci-dessous	
Type: SIGMA CORE	
respecte les directives : 2014/35/EU 2014/30/EU 2011/65/EU	
Normes européennes : EN IEC60974-1:2018/A1:2019 EN IEC60974-2:2019 EN IEC60974-5:2019 EN IEC60974-10:2014/A1:2015	
Réglementation : 2019/1784/EU	
Fait à Fjerritslev, 01.10.2022	
	
Kristian M. Madsen PDG	

- 1) Cet équipement est conforme à la norme EN / IEC61000-3-12:2014 (/ 2011), à condition que la puissance de court-circuit Ssc du réseau au point de service soit supérieure ou égale aux données figurant dans le tableau ci-dessus. Il incombe à l'installateur ou à l'utilisateur de l'équipement de vérifier, en consultant l'opérateur du réseau de distribution si nécessaire, que la puissance de court-circuit Ssc délivrée est supérieure ou égale aux données figurant dans le tableau ci-dessus.
- 2) **S** Cette machine est conforme aux normes exigées pour les machines fonctionnant dans des zones à risque élevé de choc électrique.
- 3) La machine est conçue pour une utilisation intérieure et extérieure selon les classes de protection IP23 et IP23S.
 IP23S : La machine peut être entreposée mais n'est pas destinée à être utilisée à l'extérieur pendant les précipitations à moins d'être abritée

Anslutning och igångsättning

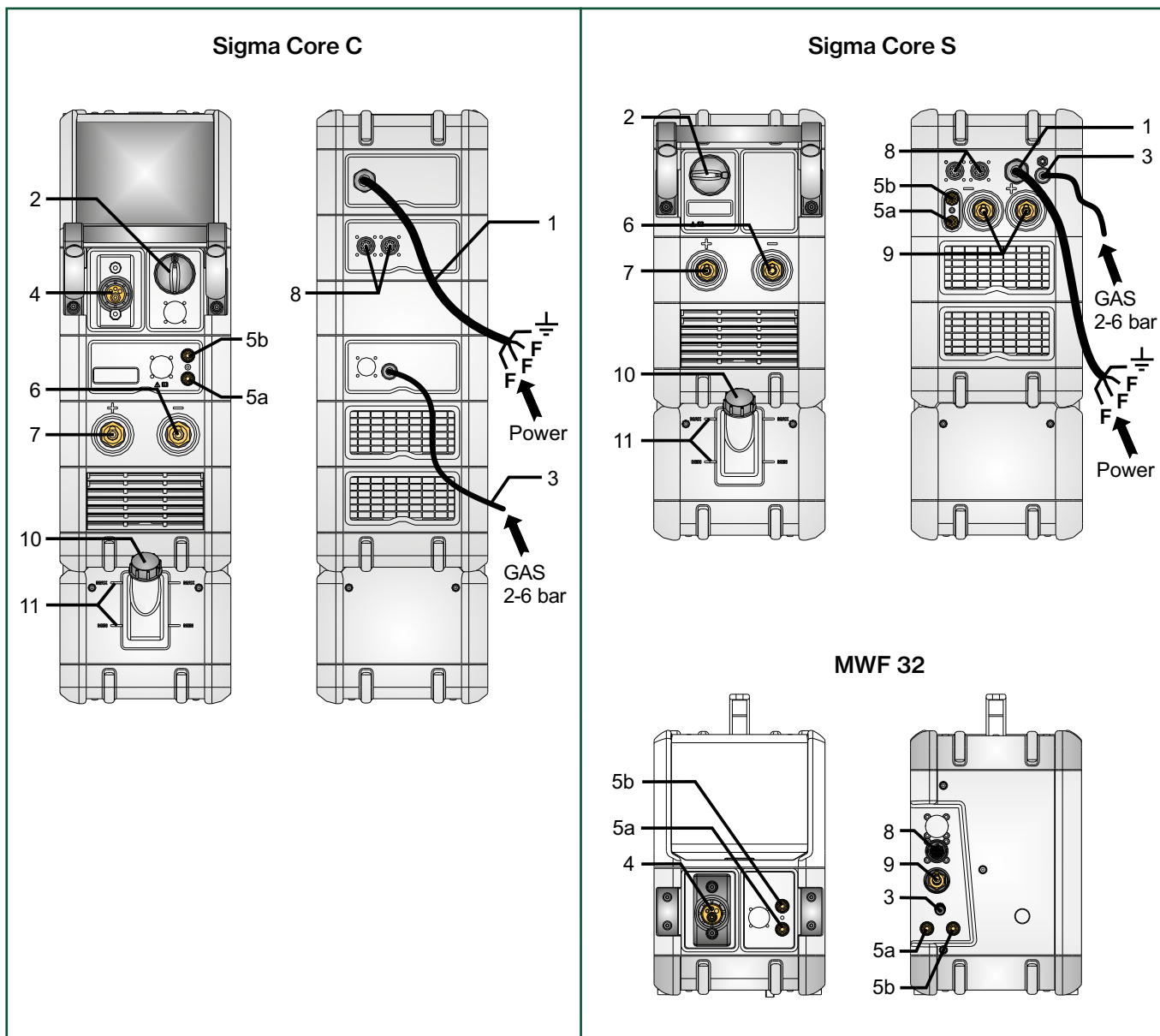

1. Nätanslutning
2. På - av knapp
3. Anslutning skyddsgas
4. Anslutning - slangpaket
- 5a. Anslutning för kylslang, framlopp (blå)
- 5a. Anslutning för kylslang, returlopp (röd)
6. Återledarklämma (MIG) eller elektrod-hållaranslutning (MMA)
7. Återledarklämma (MMA) eller elektrod-hållaranslutning (MMA)
8. Anslutning CAN och med MWF försörjning
9. Anslutning mellankabel
10. Påfyllning av kylarvätska
11. Avläsning av kylvätskenivå (Min/Max)

Anslutning och igångsättning



Varning

Läs varning och bruksanvisning noggrant innan installation och igångsättning och spara till senare bruk.

Installation

Nätanslutning

Anslut maskinen till den nätspänning den är konstruerad till. Se typskylt (U1) bak på maskinen.

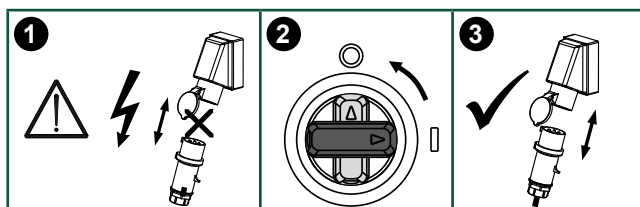
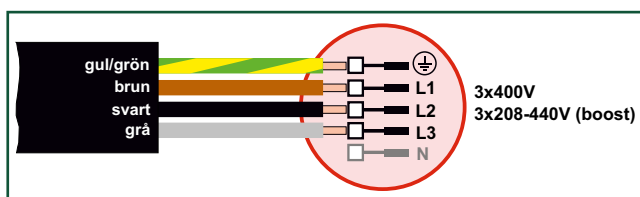

Stabiliseringskit

Strömkällan kan konfigureras med ett stabiliseringskit som skyddar mot större spänningsvariationer, t.ex. vid generatorbruk, där maskinen är inkopplad till separat nätförsörjning.

Anslutning av skyddsgas

Gasslangen, som utgår från baksidan av maskinen (3), ansluts till gasförsörjning med en reduceringsventil (2-6 bar). (Obs. Några typer av reduceringsventiler kan kräva högre utgångstryck än 2 bar för att fungera optimalt). En/två gasflaskor kan fixeras bak på vagnen.

Gasförbrukning

Beroende på svetsuppdrag, gastyp och svetsläge kan gasförbrukningen variera från 6-7 l/min. vid låga ampere (<25A) och upp till 27 l/min. vid max. ampere.

Materialförbrukning

Materialförbrukning kan beräknas genom att göra beräkningen svetsstid i minuter x trådhastighet (m/min) x vikt per meter på det aktuella tillsatsmaterialet.

Anslutning av elektrodhållare för MMA

Elektrodhållare och återledarkabel ansluts plusuttag (10) och minusuttag (8). Polariteten väljes efter elektrodleverantörens anvisning.

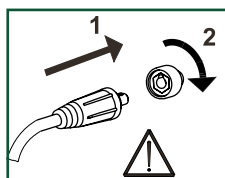

Viktigt!

När återledarkabel och slangpaket ansluts maskinen, är god elektrisk kontakt nödvändig, för att undgå att kontakter och kablar ödeläggs.

Anslutning av slangpaket

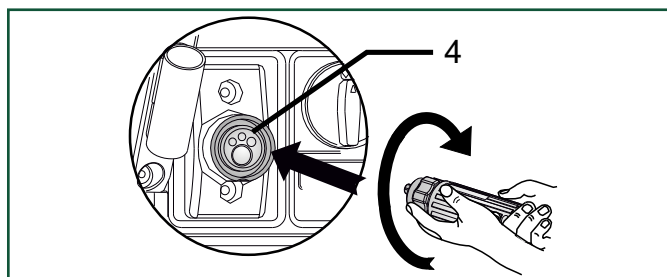

Rekommenderade kabelstorlekar

Svetsström	DC	PULS
200 A	35 mm ²	35 mm ²
300 A	50 mm ²	70 mm ²
400 A	95 mm ² / 2x50 mm ²	95 mm ² / 2x50 mm ²
550 A	2x70 mm ²	2x70 mm ²

Svetsprocess	Avstånd till arbetsämnet (a+b)	Total kabellängd i svetskretsloppet (a+b+c)
MIG - puls	10 m	20 m
MIG - ingen puls	30 m	60 m

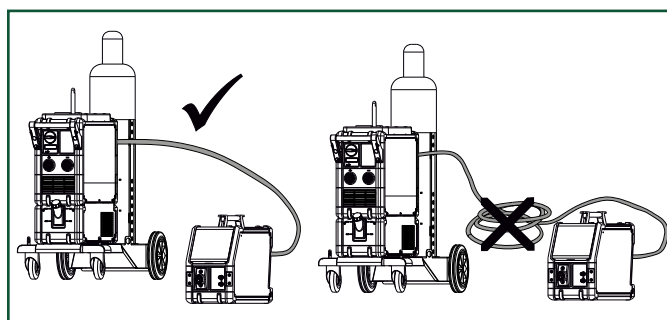
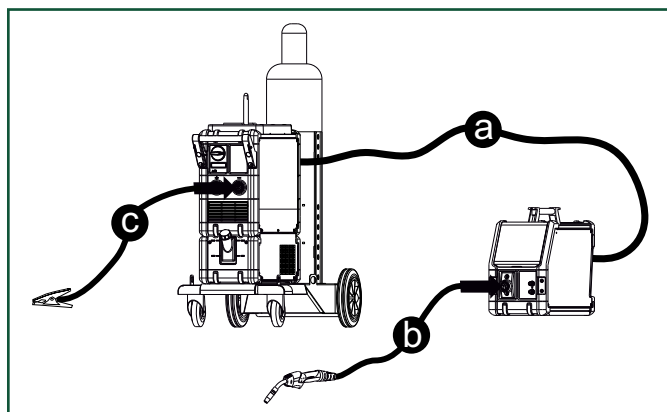

VARNING

När man trycker på slangpaketets kontakt/avtryckare är det spänning på svetstråden/elektroden.

Anslutning och igångsättning

Lyftanvisning

När maskinen skall lyftas, skall lyftpunkterna, som visas på figuren, användas.

Maskinen får ej lyftas med monterad gasflaska!

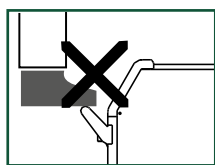
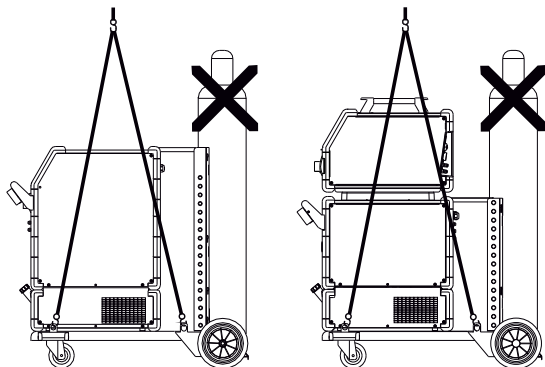

Lyft inte maskinen i handtaget.
Stå ej på handtaget.

Justering av trådbroms

Bromsen justeras så stramt att trådrullen stannar innan svetstråden kör ut över kanten på rullen. Bromskraften beror på trådrullens vikt och den trådhastigheten som används.

Fabriksinställt till 15kg.

Justering:

- Avmontera vridknappen genom att sticka in en tunn skruvmejsel bakom knappen och bänd därefter loss knappen.
- Justera trådbromsen genom att spänna eller lossa låsskruven på trådnavets axel.
- Montera vridknappen igen.

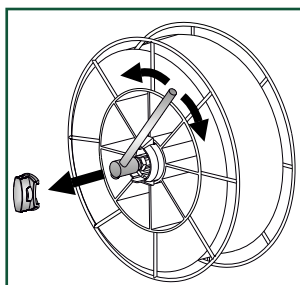

Rangering

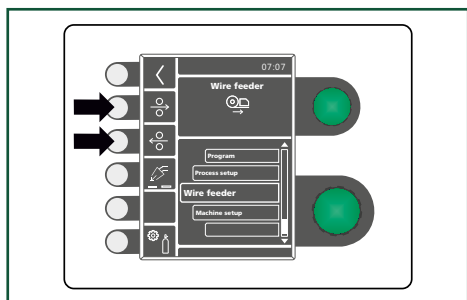
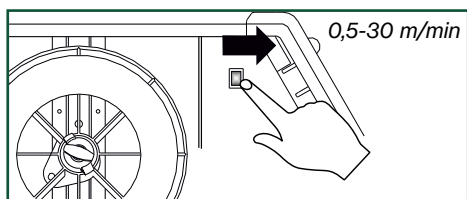

MCU utluftning

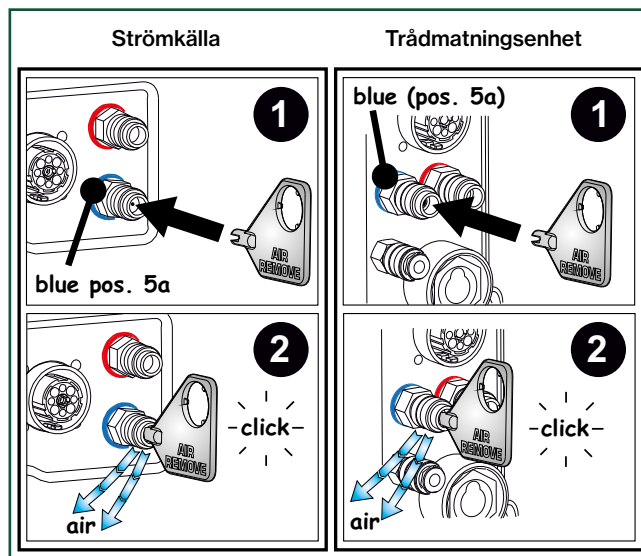

Lås- och vridfunktion MWF

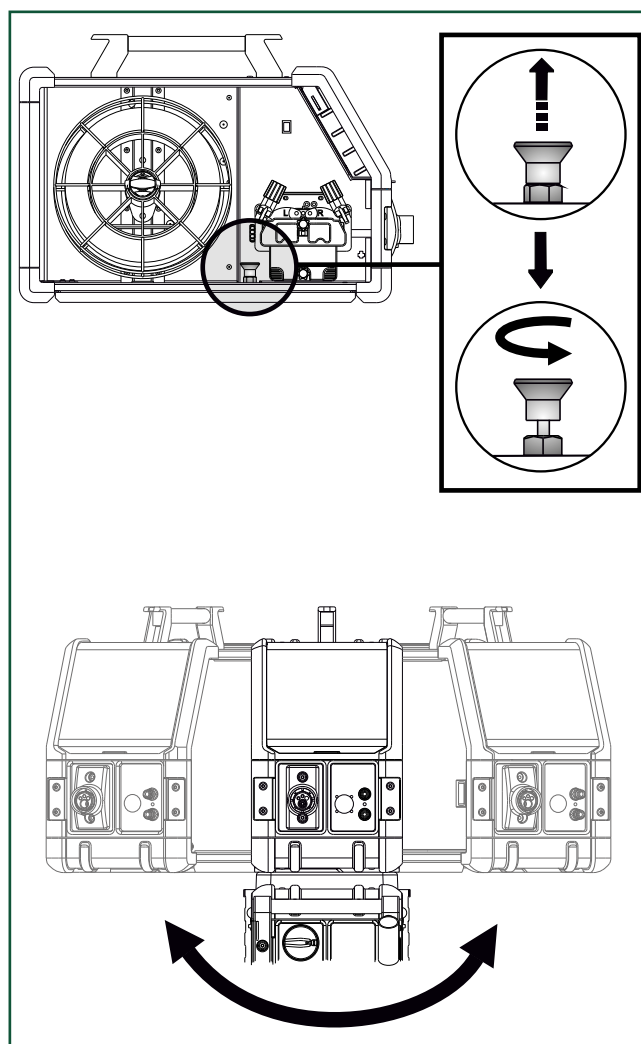

Anslutning och igångsättning

Montering av delar i trådmatningen

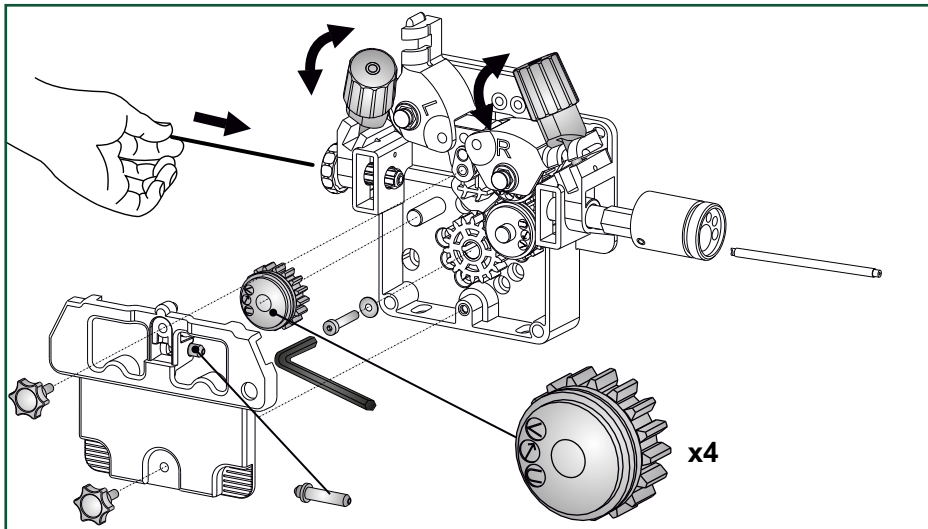

Fingerskruvens tryck ställs in, så att matarhjulen precis glider på tråden, när den bromsas vid kontaktdysan

Software uppdatering

- Sätt i SD-kortet.
- Tänd maskinen.
- Vänta tills enheten indikerar, att uppdatering är avslutad.
- Släck maskinen och ta ut SD-kortet.
- Maskinen är nu klar för användning.

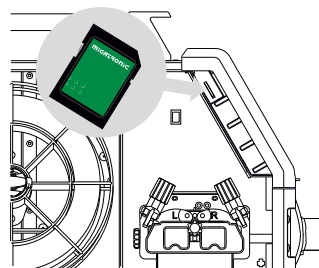

Strömkälla och alla inkopplade enheter får den nya software inläst.

Softwaren kan downloadas från <http://migatron.com> till ett SD-kort. SD-kortets filsystem skall vara formaterat till FAT32.

VIKTIGT:

Software skall sparas i mappstrukturen: //MIGA_SW/SIGMA/

Speciella funktioner

Software / Licenser

I

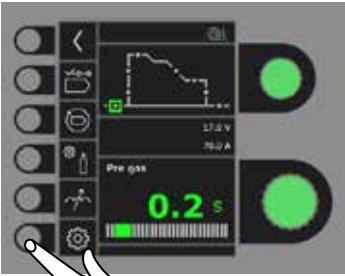

II



III

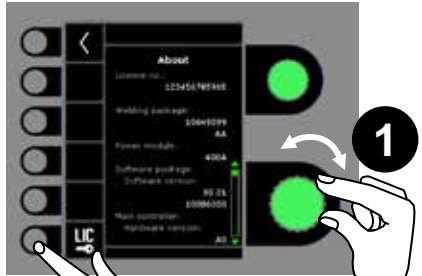

Kabelkompensation (kalibrering av modstånd i slangpaketet)

I



II

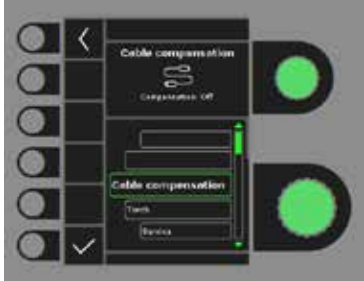

III

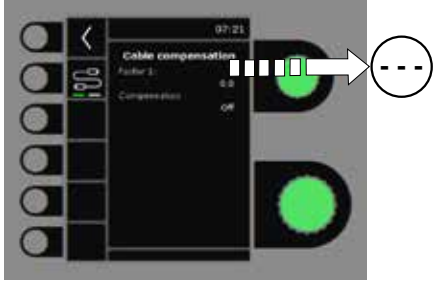

IV

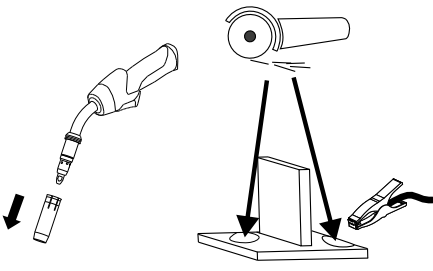

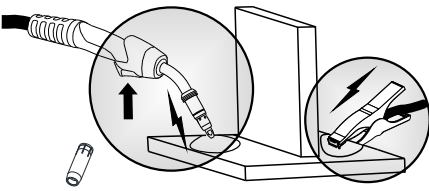

! Svetsämnets ytskikt skall vara rent för att säkra god kontakt med brännaren.

V



VI



 = Kabelkompensering aktiverat

Speciella funktioner

Kalibrering av gasflow (ej alla modeller)

<p>I</p>	<p>II</p>	<p>III</p>
<p>IV</p>	<p>V</p>	

Brännar setup

<p>I</p>	<p>II</p>	<p>III</p>
<p>IV</p>		

Felhantering

SIGMA CORE har ett avancerat skyddssystem inbyggt. Vid fel stänger maskinen automatisk för gastillförseln, avbryter svetsströmmen och stoppar trådmatningen.

Utvalda fel:

Kylfel

Kylfel visas i händelse av att kylvattnet ej kan cirkulera till följd av felaktig anslutning eller tillstopning. Kontrollera att kylslangarna är korrekt anslutna, fyll på vattenbehållaren och se över slangpaket och anslutningsrör. Kylfelen avanmäls med ett kort tryck på ✓-knappen.

Gasfel (IGC)

Gasfel kan bero på för lågt eller för högt tryck på gastillförseln. Kontrollera att trycket på gastillförseln är högre än 2 bar och mindre än 6 bar, svarande till 5 l/min och 27 l/min.

Gasfel kan kopplas ur funktion genom att ställa in manuell gasflow på 27 l/min. Gasfelen avanmäls med ett kort tryck på ✓-knappen.

OBS! Det är viktigt, att det angivna trycket på gastillförseln kan upprätthållas under svetsning.

Fellog

I

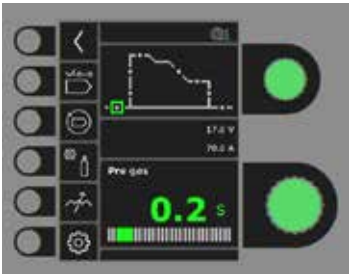

II

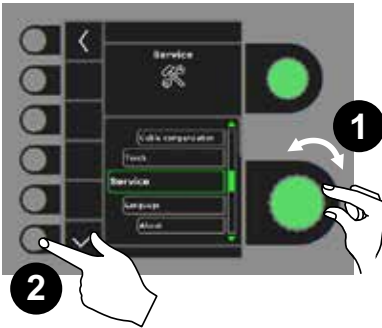

III

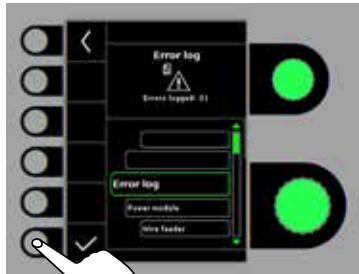

IV

Fellog

Alla fel sparas i maskinens fellog under menyn Service.

Felloggen kan distribueras, när man sätter in ett SD-kort och trycker på följande knapp:



Felloggen är nu sparad på SD-kortet.

Felloggen kan nollställas, när man trycker på knappen utanför papperskorgen.



Teknisk data 1

STRÖMKÄLLA	300		400		550	
Nätspänning $\pm 15\%$ (50-60Hz), V	3x400		3x400		3x400	
Minimum generatorstorlek, kVA	16		27		40	
¹ Minimum kortslutningseffekt Ssc, MVA	3,7		6,0		9,5	
Säkring, A	16		20		35	
Nätström effektiv, A	10,5		17,5		27,2	
Nätström max., A	15,4		26,0		39,2	
Effekt 100%, kVA	9,0		12,1		18,9	
Effekt max., kVA	10,7		18,0		27,1	
Effekt tomgång, W	11		12		12	
Verkningsgrad,%	87		89		90	
Powerfaktor	0,90		0,90		0,90	
	MIG	MMA	MIG	MMA	MIG	MMA
Strömområde, A	15-300	15-250	15-400	15-400	15-550	15-550
Intermittens 100% 20°C, A	290/28,5	250/30,0	345/31,5	345/33,8	475/37,8	475/39,0
Intermittens max. 20°C, A/%/V			400/65/34,0	400/65/36,0	550/60/41,5	550/60/42,0
Intermittens 100% 40°C, A/V	220/25,0	210/28,4	300/29,0	300/32,0	430/35,5	430/37,2
Intermittens 60% 40°C, A/V	230/25,5	220/28,8	370/32,5	370/34,8	510/39,5	510/40,4
Intermittens max. 40°C, A/%/V	300/25/29,0	250/35/30,0	400/50/34,0	400/45/36,0	550/50/41,5	550/50/42,0
Tomgångsspänning, V	50-60		65-75		75-80	
² Användarklass	S/CE		S/CE		S/CE	
³ Skyddsklass	IP23S		IP23		IP23	
Norm, C	IEC60974-1, IEC60974-5, IEC60974-10 Cl. A					
Norm, S	IEC60974-1, IEC60974-10 Cl. A					
Mått C (HxBxL), mm	700x260x735		700x260x735		700x260x735	
Mått S (HxBxL), mm	454x260x735		454x260x735		454x260x735	
Vikt C / S, kg	36,9 / 26		52 / 35		53 / 36	

STRÖMKÄLLA	300 Boost				400 Boost			
Nätspänning $\pm 10\%$ (50-60Hz), V	3x208-380		3x380-440		3x208-380		3x380-440	
Minimum generatorstorlek, kVA	16		16		25		25	
¹ Minimum kortslutningseffekt Ssc, MVA	1,7		3,75					
Säkring, A	20		16		25-50		25-50	
Nätström effektiv, A	19,5		10,6		22,0		11,7	
Nätström max., A	31,6		16,2		45,0		23,5	
Effekt 100%, kVA	7,1		7,0		8,3		8,1	
Effekt max., kVA	11,0		10,6		16,7		16,3	
Effekt tomgång, W	45		16		60		56	
Verkningsgrad,%	82		87		84		88	
Powerfaktor	0,95		0,95		0,96		0,95	
	MIG	MMA	MIG	MMA	MIG	MMA	MIG	MMA
Strömområde, A	15-300	15-250	15-300	15-250	15-400	15-400	15-400	15-400
Intermittens 100% 20°C, A	250/26,5		250/26,5		300/29,0	300/32,0	300/29,0	300/32,0
Intermittens max. 20°C, A/%/V	300/40/29,0		300/40/29,0		400/30/34,0	400/30/32,0	400/30/34,0	400/30/32,0
Intermittens 100% 40°C, A/V	200/24,0	200/28,0	200/24,0	200/28,0	250/26,5	220/28,8	250/26,5	220/28,8
Intermittens 60% 40°C, A/V	210/24,5	210/28,4	210/24,5	210/28,4	280/28,0	260/30,4	280/28,0	260/30,4
Intermittens max. 40°C, A/%/V	300/25/29,0	250/35/30,0	300/25/29,0	250/35/30,0	400/25/34,0	400/20/36,0	400/25/34,0	400/20/36,0
Tomgångsspänning, V	50-60				70-75			
² Användarklass	S/CE				S/CE			
³ Skyddsklass	IP23S				IP23			
Norm, C	IEC60974-1, IEC60974-5, IEC60974-10 Cl. A				IEC60974-1, IEC60974-5, IEC60974-10 Cl. A			
Norm, S	IEC60974-1, IEC60974-10 Cl. A				IEC60974-1, IEC60974-10 Cl. A			
Mått C (HxBxL), mm	700x260x735				900x260x735			
Mått S (HxBxL), mm	454x260x735				654x260x735			
Vikt C / S, kg	45 / 34				66 / 49			

- Denna utrustning är i överensstämmelse med EN / IEC61000-3-12:2014 (/ 2011), förudsatt att nätets kortslutningseffekt Ssc vid anslutningsstället är större än eller lika med uppgivna data i ovanstående schema. Installatören eller användaren av utrustningen är ansvarig för att säkra, evt. i samråd med försörjningsdistributören, att utrustningen är anslutet till en nätförsörjning med en kortslutningseffekt Ssc större än eller lika med de uppgivna data i ovanstående schema.
- S** Maskiner uppfyller de krav som ställs för användning i områden med ökad risk för elektrisk chock
- Maskinen är godkänd till inomhus och utomhus användning enligt skyddsklass IP23 / IP23S.
IP23S: Maskinen kan förvaras men är inte beräknad för att användas utomhus vid nederbörd, om den inte är avskärmad.

Teknisk data 2

MATERVERK MWF	
Trådmatningshastighet, m/min	0,5-30,0
Brännaranslutning	EURO
Trådspolediameter, mm	300
Trådrulle, kg	5-18
Intermittens 100 % 40°C, A/%	430
Intermittens 60% 40°C, A/%	500
Intermittens max. 40°C A/%	550/50
³⁾ Skyddsklass	IP23
Tråddiameter, mm	0,6-1,6
Gastrykk, MPa (bar)	0,6 (6,0)
Mått (HxBxL), mm	457x260x672,5
Vikt, kg	14,0
Norm	IEC60974-5, IEC60974-10 CL. A

KYLMODUL MCU 1300	
Kyleffekt (1 l/min), W	1300
Kyleffekt (1,5 l/min), W	1600
Tanncapacitet, liter	5
Flow, bar - °C - l/min	3,0-60-1,5
Tryck max., bar	5
Norm	IEC60974-2, IEC60974-10 CL.A
Mått (HxBxL), mm	207x260x680
Vikt	20

EU FÖRSÄKRAN OM ÖVERENSSTÄMMELSE



MIGATRONIC A/S
Aggersundvej 33
9690 Fjerritslev
Danmark

Härmed försäkras vi att våra maskiner enligt nedan

Typ: SIGMA CORE

överensstämmer med riktlinjerna

i direktiven: 2014/35/EU
2014/30/EU
2011/65/EU

Europeiska EN IEC60974-1:2018/A1:2019
standarder: EN IEC60974-2:2019
EN IEC60974-5:2019
EN IEC60974-10:2014/A1:2015

Förordning: 2019/1784/EU

Utfärdad i Fjerritslev 01.10.2022

Kristian M. Madsen
CEO

- 1) Denna utrustning är i överensstämmelse med EN / IEC61000-3-12:2014 (/ 2011), förudsatt att nätets kortslutningseffekt Ssc vid anslutningsstället är större än eller lika med uppgivna data i ovanstående schema. Installatören eller användaren av utrustningen är ansvarig för att säkra, evt. i samråd med försörjningsdistributören, att utrustningen är anslutet till en nätförsörjning med en kortslutningseffekt Ssc större än eller lika med de uppgivna data i ovanstående schema.
- 2) **S** Maskiner uppfyller de krav som ställs för användning i områden med ökad risk för elektrisk chock
- 3) Maskinen är godkänd till inomhus och utomhus användning enligt skyddsklass IP23 / IP23S.
IP23S: Maskinen kan förvaras men är inte beräknad för att användas utomhus vid nederbörd, om den inte är avskärmad.

Collegamenti ed uso

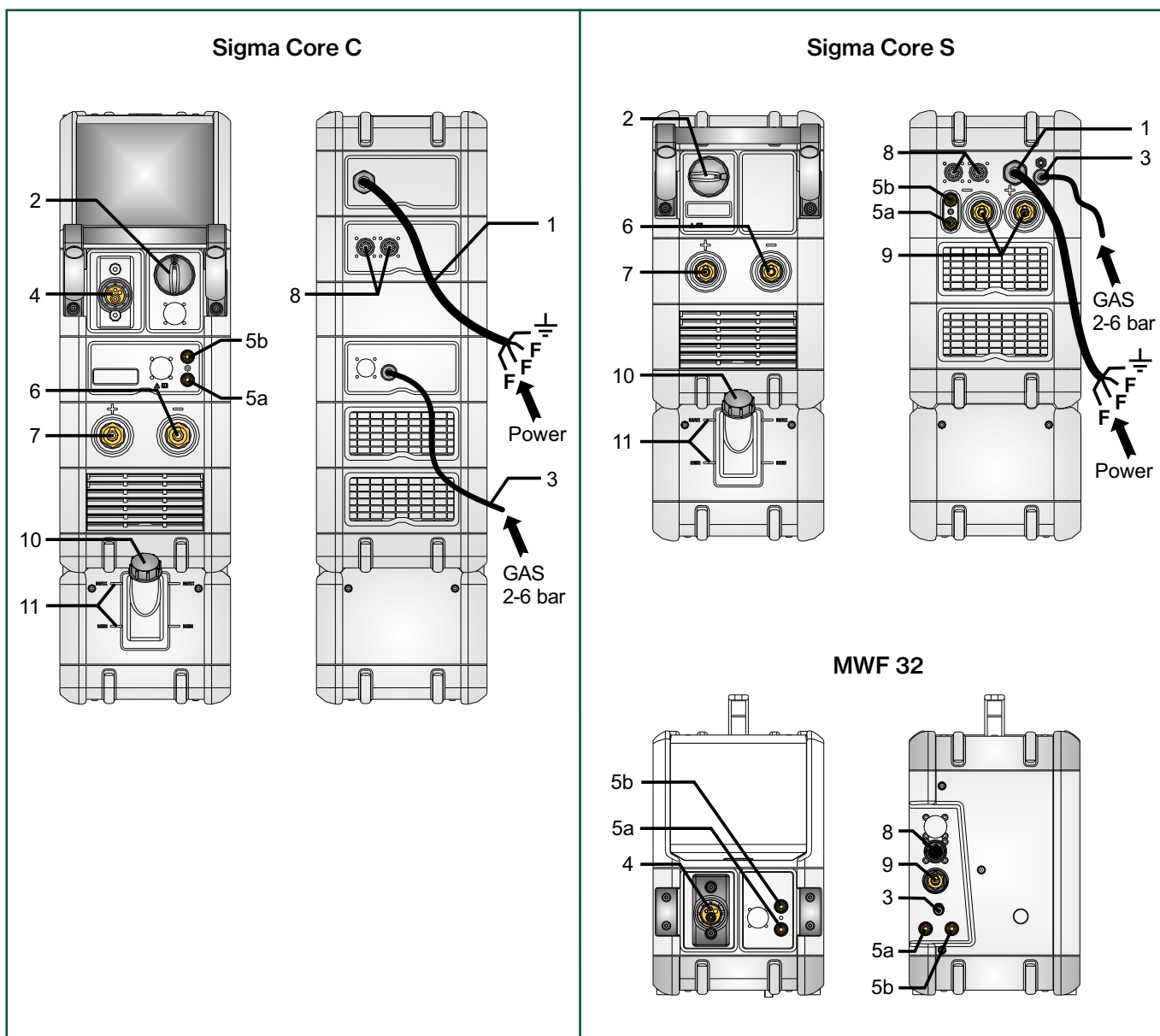

1. Collegamento elettrico
2. Interruttore ON/OFF
3. Collegamento del gas di protezione
4. Collegamento della torcia
- 5a. Collegamento tubo raffreddamento, mandata (blu)
- 5b. Collegamento tubo raffreddamento, ritorno (rosso)
6. Collegamento cavo di massa (MIG) o cavo portaelettrodo (MMA)
7. Collegamento cavo di massa (MMA) o cavo portaelettrodo (MMA)
8. Collegamento CAN-BUS ed alimentazione MWF
9. Collegamento fascio cavi
10. Rabbocco liquido raffreddamento
11. Controllo livello liquido di raffreddamento (Min/Max)

Collegamenti ed uso



Attenzione

Leggere attentamente le avvertenze e il manuale prima della messa in funzione e salvare le informazioni per un uso futuro.

Installazione

Collegamento elettrico

Collegare la macchina alla corretta alimentazione elettrica. Verificare il valore (U_e) sulla targa dati situata sul retro della macchina.

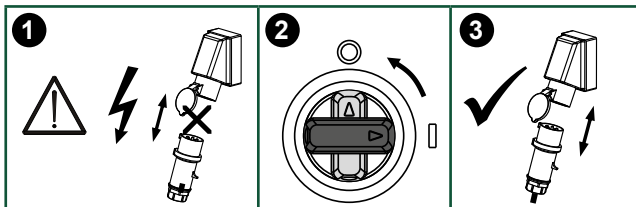
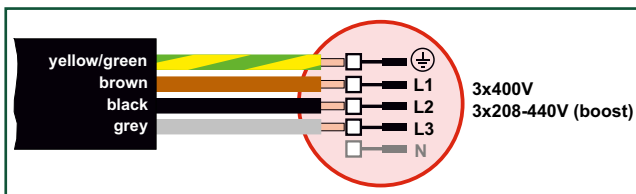

Kit stabilizzatore di tensione

Il generatore di potenza è possibile configurarla con un kit di stabilizzazione della tensione come protezione contro variazioni di tensione maggiori, ad es. Nel caso di utilizzo della saldatrice con un gruppo di alimentazione separato, tipo generatore.

Collegamento all'alimentazione gas

Collegare il tubo del gas, posizionato sul pannello posteriore della saldatrice (3), ad una alimentazione di gas con regolatore di pressione (2-6 bar). (Nota: alcuni tipi di regolatori richiedono una pressione di uscita superiore a 2 bar per funzionare in modo ottimale). Una/due bombole di gas possono essere montato sul carrello portabombole.

Consumo di gas

A seconda dell'attività di saldatura, del tipo di gas e del design del cordone, il consumo di gas varierà in intervalli da 6-7 l / min a bassi amperaggi (<25 A) e fino a 27 l / min a max. amperaggio.

Consumo di materiale

Il consumo di materiale può essere stimato calcolando il tempo di saldatura in minuti moltiplicato per la velocità di avanzamento del filo (m/min) moltiplicato per il peso al metro dei consumabili di saldatura in uso.

Collegamento della pinza portaelettrodo per MMA

Il cavo portaelettrodo e quello di massa vanno collegati al polo positivo (10) e negativo (8). Osservare le istruzioni del fornitore dell'elettrodo nello scegliere la polarità.

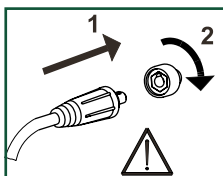

Importante!

Per evitare danni alle prese e ai cavi è importante verificare che ci sia un buon contatto elettrico quando si collegano i cavi di saldatura.

Collegamento della torcia

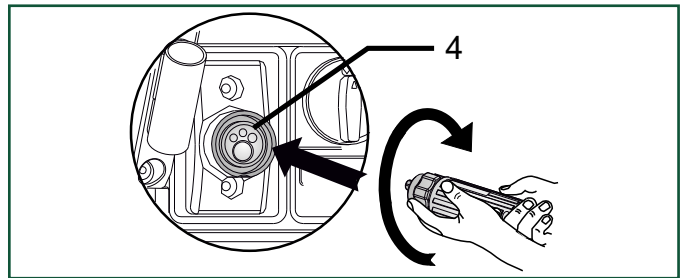

Sezione dei cavi consigliata

AMPERE	DC	PULSATO
200 A	35 mm ²	35 mm ²
300 A	50 mm ²	70 mm ²
400 A	95 mm ² / 2x50 mm ²	95 mm ² / 2x50 mm ²
550 A	2x70 mm ²	2x70 mm ²

Processo di saldatura	Distanza dal pezzo (a+b)	Lunghezza massima dei cavi di saldatura (a+b+c)
MIG - pulsato	10 m	20 m
MIG - non pulsato	30 m	60 m

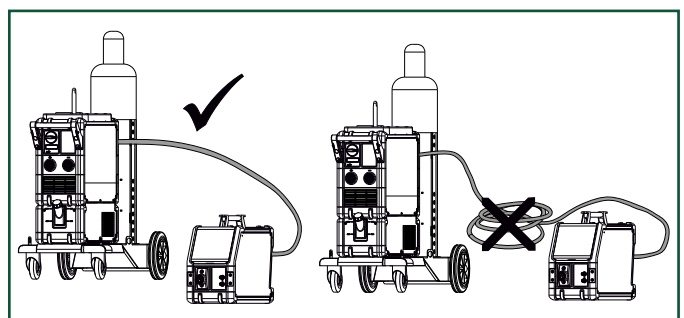
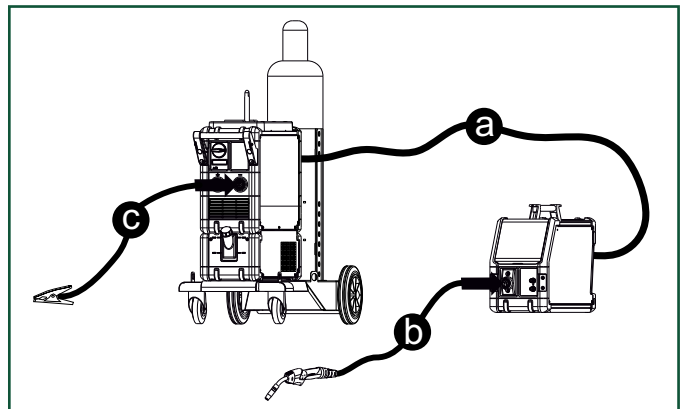

ATTENZIONE

Quando si schiaccia il pulsante torcia c'è presenza di tensione elettrica sul filo di saldatura/sull'elettrodo.

Collegamenti ed uso

Istruzioni di sollevamento

I punti di sollevamento devono essere utilizzati (vedere la figura) quando si solleva la macchina. La macchina non deve essere sollevata con la bombola del gas montata.

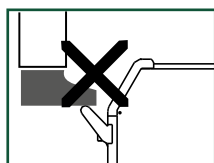
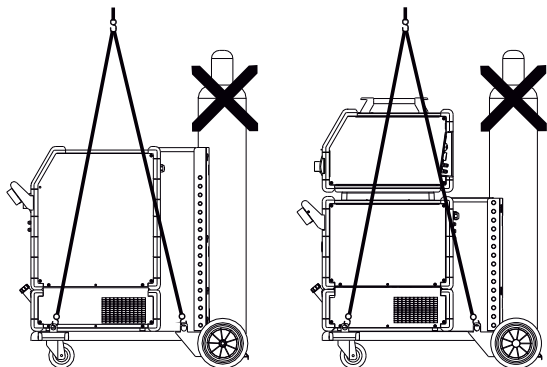

Non sollevare la macchina per la maniglia.
Non calpestare la maniglia.

Regolazione del freno del filo

Il freno nell'aspo portabobina assicura che la bobina non continui a srotolarsi alla fine della saldatura. La forza del freno dipende dal peso della bobina di filo e dalla velocità del trainafilo. Il valore di fabbrica è 15kg

Regolazione freno:

- Smontate la manopola di blocco infilando un cacciavite sottile dietro la manopola e tiratela fuori.
- Regolate il freno del filo stringendo o allentando il dado sull'albero dell'aspo.
- Reinserrire la manopola di blocco.

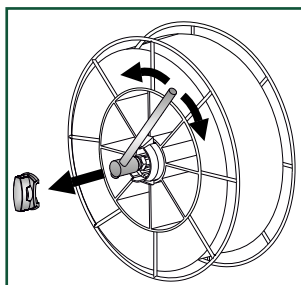

Avanzamento del filo

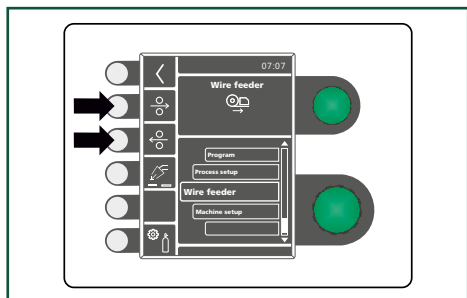
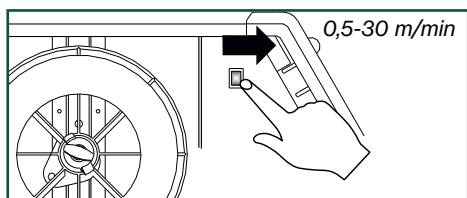

Ventilazione MCU

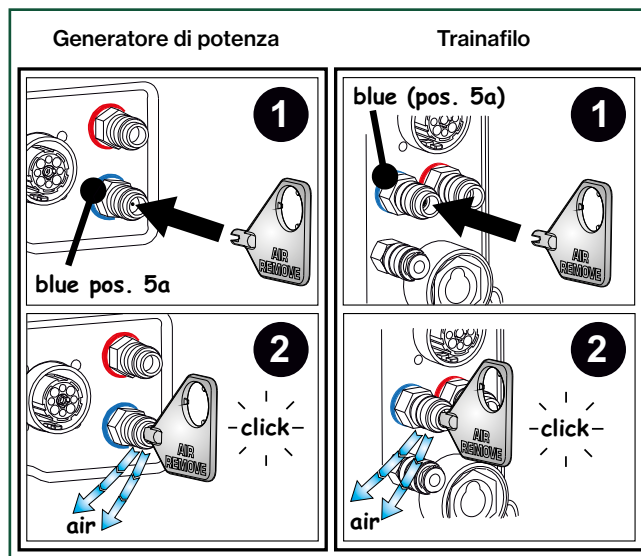

Funzione di blocco MWF

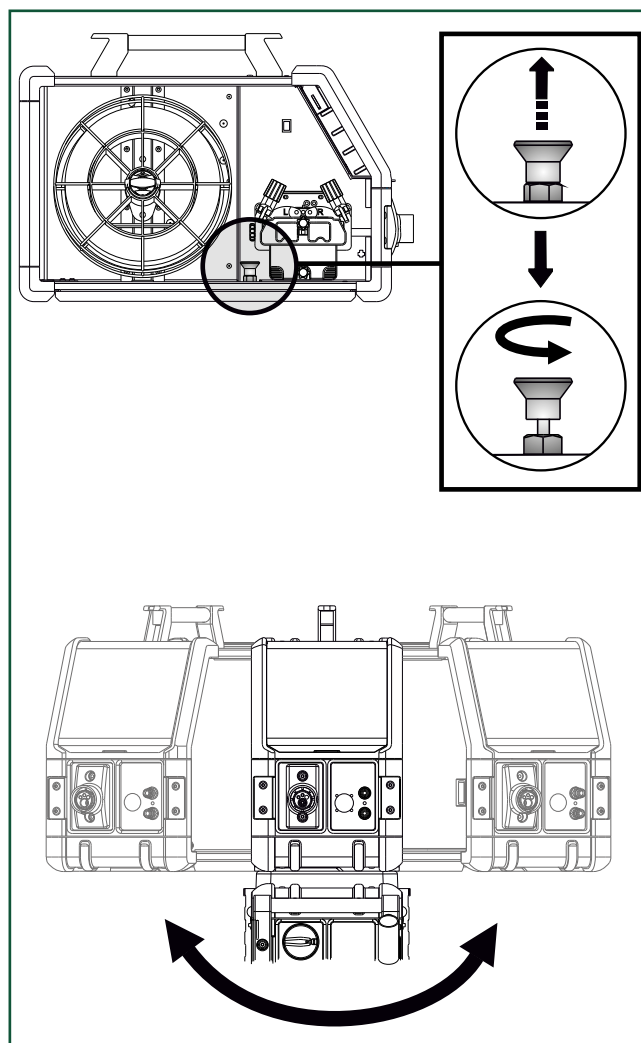

Collegamenti ed uso

Assemblaggio parti traina filo

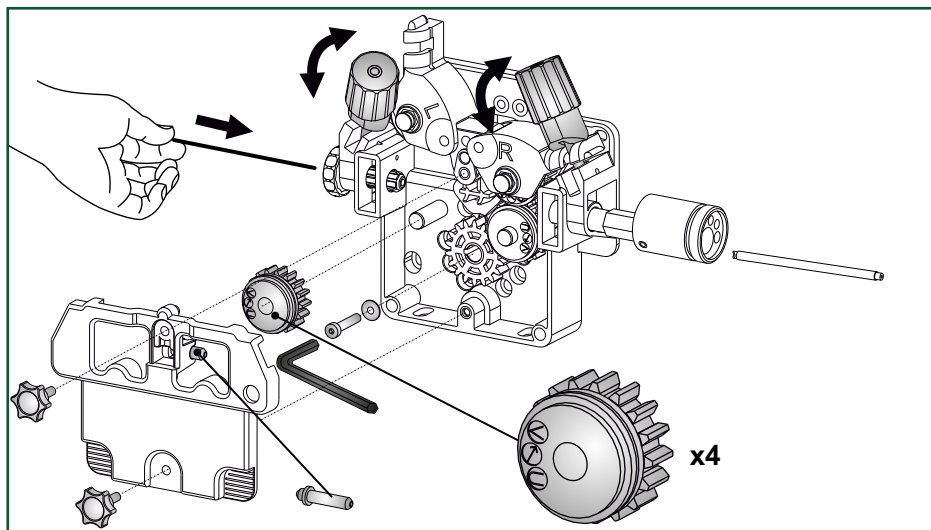

La pressione della vite di regolazione deve essere tale che i rulli slittino sul filo quando questo viene bloccato.

Aggiornamento Software

- Caricamento software.
- Accendere la macchina.
- Attendere che l'unità indichi che l'aggiornamento è completato.
- Spegner la macchina e rimuovere la carta SD.
- La macchina è ora pronta all'uso.

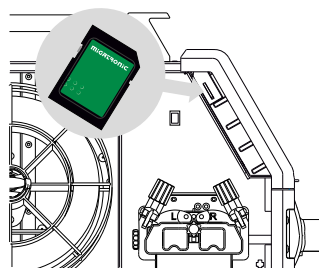

Il nuovo software verrà caricato nella saldatrice ed in tutte le unità collegate.

Il software si può scaricare da : <http://migatronic.com> su una scheda SD. La scheda SD deve essere formattata FAT32.

IMPORTANTE:

Salvare il software nella directory //MIGA_SW/SIGMA/

Funzioni speciali

Software / Licenze

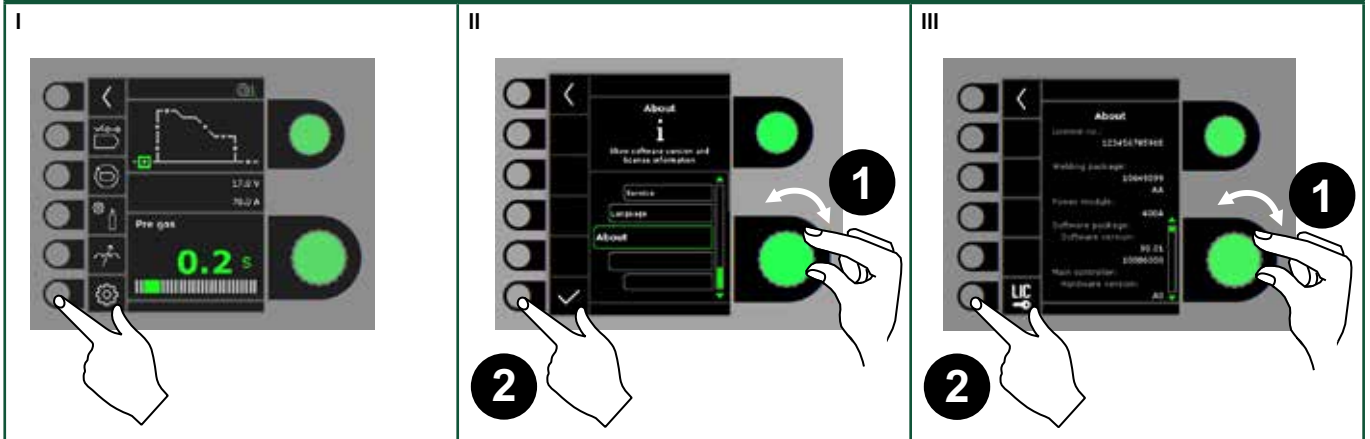

Compensazione fascio cavi (calibrazione della resistenza del fascio cavi)

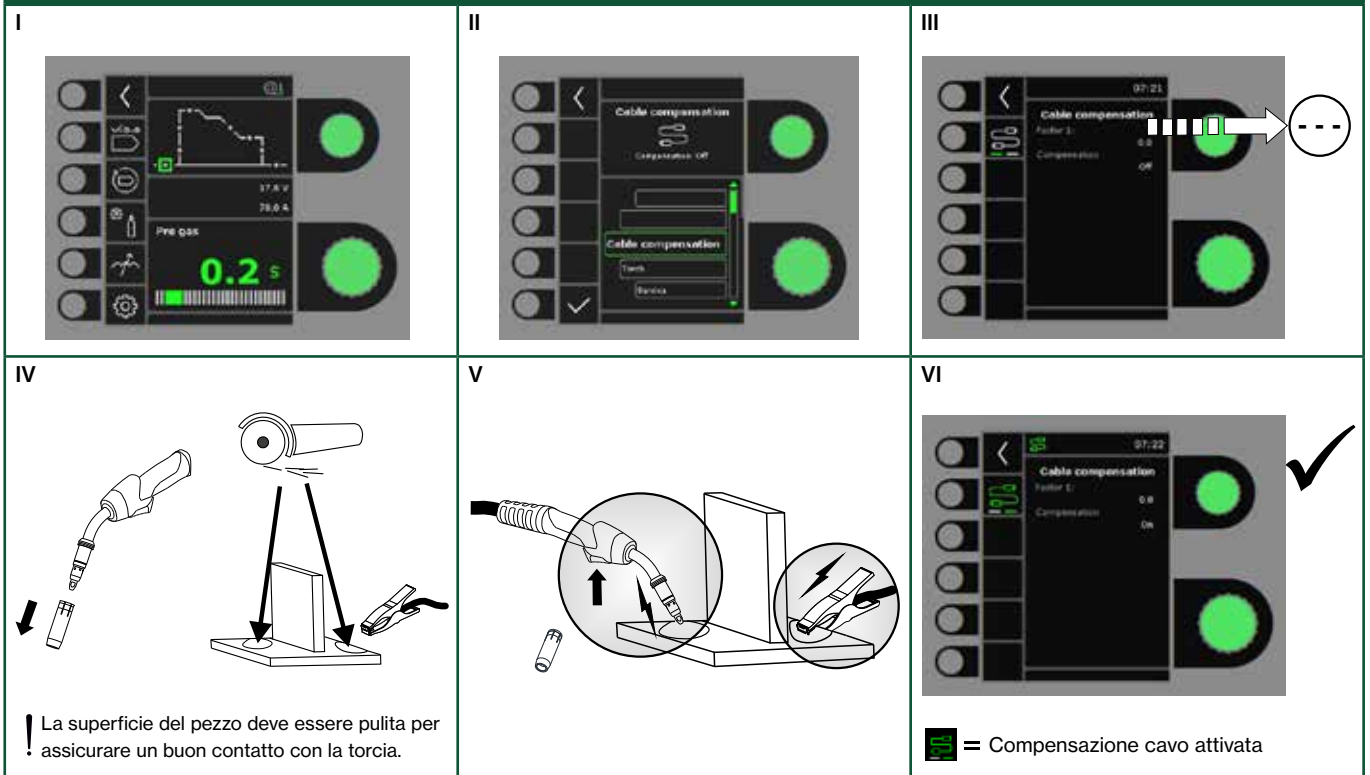

Funzioni speciali

Calibrazione del flusso di gas (non presente in tutti i modelli)

<p>I</p>	<p>II</p>	<p>III</p>
<p>IV</p>	<p>V</p>	

Configurazione Torcia

<p>I</p>	<p>II</p>	<p>III</p>
<p>IV</p>		

Gestione errori

SIGMA CORE ha un sofisticato sistema di autoprotezione. In caso di allarme la macchina interrompe automaticamente il gas il filo e la corrente.

Esempi di errore :



Allarme raffreddamento torcia

Questo errore viene indicato solo nelle machine dotate di flussostato in caso di mancata circolazione acqua. Controllate che i tubi siano correttamente collegati, riempire il serbatoio dell'acqua e controllare la torcia. L'allarme raffreddamento si cancella schiacciando brevemente il tasto ✓.

Errore gas (IGC)

L'errore è dovuto a pressione del gas troppo bassa o troppo alta. Assicurarsi che la pressione d'uscita del gas sia compresa tra 2 e 6 bar, corrispondenti a 5 e 27 l/min. L'allarme viene disinserito regolando la portata a 27 l/min. L'allarme viene spento premendo brevemente il tasto ✓.

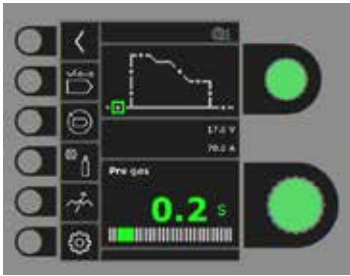
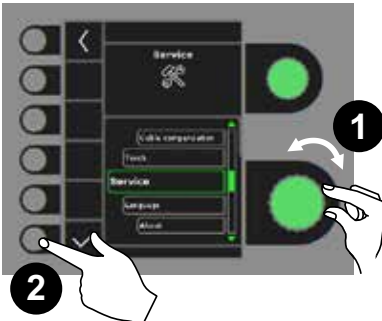
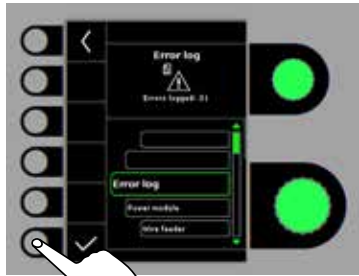
Nota: è importante che durante la saldatura venga mantenuta la fornitura di gas indicata.

Registrazione errori		
<p>I</p> 	<p>II</p> 	<p>III</p> 
<p>IV</p> <p>Registrazione errori</p> <p>Tutti gli errori verificatisi sono salvati in una memoria nel Menù Service. Tali errori possono anche essere memorizzati su carta SD inserendo la carta e schiacciando il tasto seguente :</p> <p>A questo punto gli errori sono salvati sulla carta SD.</p> <p>Schiacciando il tasto che indica il cestino la memoria errori viene svuotata.</p>		

Dati tecnici 1

GENERATORE	300		400		550	
Tensione alimentazione $\pm 15\%$ (50-60Hz), V	3x400		3x400		3x400	
Dimensione minima generatore, kVA	16		27		40	
¹ Minima Potenza Corto-circuito Ssc, MVA	3,7		6,0		9,5	
Fusibile, A	16		20		35	
Corrente primaria effettiva, A	10,5		17,5		27,2	
Corrente primaria max., A	15,4		26,0		39,2	
Assorbimento 100%, kVA	9,0		12,1		18,9	
Assorbimento max., kVA	10,7		18,0		27,1	
Potenza, circuito aperto, W	11		12		12	
Rendimento, %	87		89		90	
Fattore di potenza	0,90		0,90		0,90	
	MIG	MMA	MIG	MMA	MIG	MMA
Gamma di corrente, A	15-300	15-250	15-400	15-400	15-550	15-550
100% intermittenza 20°C, A	290/28,5	250/30,0	345/31,5	345/33,8	475/37,8	475/39,0
Max. intermittenza 20°C, A/%/V			400/65/34,0	400/65/36,0	550/60/41,5	550/60/42,0
100% intermittenza 40°C, A/V	220/25,0	210/28,4	300/29,0	300/32,0	430/35,5	430/37,2
60% intermittenza 40°C, A/V	230/25,5	220/28,8	370/32,5	370/34,8	510/39,5	510/40,4
Max. intermittenza 40°C, A/%/V	300/25/29,0	250/35/30,0	400/50/34,0	400/45/36,0	550/50/41,5	550/50/42,0
Tensione a vuoto, V	50-60		65-75		75-80	
² Classe di applicazione	S/CE		S/CE		S/CE	
³ Classe protezione	IP23S		IP23		IP23	
Norme, C	IEC60974-1, IEC60974-5, IEC60974-10 Cl. A					
Norme, S	IEC60974-1, IEC60974-10 Cl. A					
Dimensioni C (AxLxP), mm	700x260x735		700x260x735		700x260x735	
Dimensioni S (AxLxP), mm	454x260x735		454x260x735		454x260x735	
Peso C / S, kg	36,9 / 26		52 / 35		53 / 36	

GENERATORE	300 Boost				400 Boost			
Tensione alimentazione $\pm 10\%$ (50-60Hz), V	3x208-380		3x380-440		3x208-380		3x380-440	
Dimensione minima generatore, kVA	16		16		25		25	
¹ Minima Potenza Corto-circuito Ssc, MVA	1,7		3,75					
Fusibile, A	20		16		25-50		25-50	
Corrente primaria effettiva, A	19,5		10,6		22,0		11,7	
Corrente primaria max., A	31,6		16,2		45,0		23,5	
Assorbimento 100%, kVA	7,1		7,0		8,3		8,1	
Assorbimento max., kVA	11,0		10,6		16,7		16,3	
Potenza, circuito aperto, W	45		16		60		56	
Rendimento, %	82		87		84		88	
Fattore di potenza	0,95		0,95		0,96		0,95	
	MIG	MMA	MIG	MMA	MIG	MMA	MIG	MMA
Gamma di corrente, A	15-300	15-250	15-300	15-250	15-400	15-400	15-400	15-400
100% intermittenza 20°C, A	250/26,5		250/26,5		300/29,0	300/32,0	300/29,0	300/32,0
Max. intermittenza 20°C, A/%/V	300/40/29,0		300/40/29,0		400/30/34,0	400/30/32,0	400/30/34,0	400/30/32,0
100% intermittenza 40°C, A/V	200/24,0	200/28,0	200/24,0	200/28,0	250/26,5	220/28,8	250/26,5	220/28,8
60% intermittenza 40°C, A/V	210/24,5	210/28,4	210/24,5	210/28,4	280/28,0	260/30,4	280/28,0	260/30,4
Max. intermittenza 40°C, A/%/V	300/25/29,0	250/35/30,0	300/25/29,0	250/35/30,0	400/25/34,0	400/20/36,0	400/25/34,0	400/20/36,0
Tensione a vuoto, V	50-60				70-75			
² Classe di applicazione	S/CE				S/CE			
³ Classe protezione	IP23S				IP23			
Norme, C	IEC60974-1, IEC60974-5, IEC60974-10 Cl. A				IEC60974-1, IEC60974-5, IEC60974-10 Cl. A			
Norme, S	IEC60974-1, IEC60974-10 Cl. A				IEC60974-1, IEC60974-10 Cl. A			
Dimensioni C (AxLxP), mm	700x260x735				900x260x735			
Dimensioni S (AxLxP), mm	454x260x735				654x260x735			
Peso C / S, kg	45 / 34				66 / 49			

- Questa macchina è conforme alla norma EN / IEC61000-3-12:2014 (/ 2011) a condizione che la potenza di corto-circuito della rete Ssc nel punto di alimentazione sia superiore o uguale al valore indicato nella tabella. E' responsabilità dell'utilizzatore o dell'installatore, eventualmente consultando il distributore di energia elettrica, che la macchina sia collegata solo ad un'alimentazione con una potenza di corto-circuito Ssc uguale o superiore al valore indicato nella tabella.
- S** La macchina è conforme agli standard per impianti destinati a lavorare in ambienti ad alto rischio elettrico.
- La macchina è progettata per uso interno ed esterno secondo la classe di protezione IP23 / IP23S.
IP23S: la macchina può essere conservata ma non è concepita per essere utilizzata all'esterno durante le precipitazioni a meno che non sia riparata.

Dati tecnici 2

TRAINAFILO MWF	
Velocità filo, m/min	0,5-30,0
Attacco torcia	EURO
Diametro bobina, mm	300
Bobina di filo, kg	5-18
100% intermittenza 40°C, A/%	430
60% intermittenza 40°C, A/%	500
Max. intermittenza 40°C A/%	550/50
³⁾ Classe protezione	IP23
Diametro filo, mm	0,6-1,6
Pressione gas, MPa (bar)	0,6 (6,0)
Dimensioni (AxLxP), mm	457x260x672,5
Peso, kg	14,0
Norme	IEC60974-5, IEC60974-10 CL. A

UNITÀ DI RAFFREDDAMENTO MCU 1300	
Efficienza di raffreddamento (1 l/min), W	1300
Efficienza di raffreddamento (1,5 l/min), W	1600
Capacità serbatoio, litri	5
Portata, bar - °C - l/min	3,0-60-1,5
Pressione max., bar	5
Norme	IEC60974-2, IEC60974-10 CL.A
Dimensioni (AxLxP), mm	207x260x680
Peso	20

DICHIARAZIONE DI CONFORMITÀ	
	
MIGATRONIC A/S Aggersundvej 33 9690 Fjerritslev Denmark	
Con la presente si dichiara che la nostra macchina	
Tipo: SIGMA CORE	
conforme alle direttive: 2014/35/EU 2014/30/EU 2011/65/EU	
Standard Europei: EN IEC60974-1:2018/A1:2019 EN IEC60974-2:2019 EN IEC60974-5:2019 EN IEC60974-10:2014/A1:2015	
Regolamento: 2019/1784/EU	
Emesso in Fjerritslev 01.10.2022	
	
Kristian M. Madsen CEO	

- 1) Questa macchina è conforme alla norma EN / IEC61000-3-12:2014 (/ 2011) a condizione che la potenza di corto-circuito della rete Ssc nel punto di alimentazione sia superiore o uguale al valore indicato nella tabella. E' responsabilità dell'utilizzatore o dell'installatore, eventualmente consultando il distributore di energia elettrica, che la macchina sia collegata solo ad un'alimentazione con una potenza di corto-circuito Ssc uguale o superiore al valore indicato nella tabella.
- 2) **S** La macchina è conforme agli standard per impianti destinati a lavorare in ambienti ad alto rischio elettrico.
- 3) La macchina è progettata per uso interno ed esterno secondo la classe di protezione IP23 / IP23S.
IP23S: la macchina può essere conservata ma non è concepita per essere utilizzata all'esterno durante le precipitazioni a meno che non sia riparata.

Aansluiting en bediening

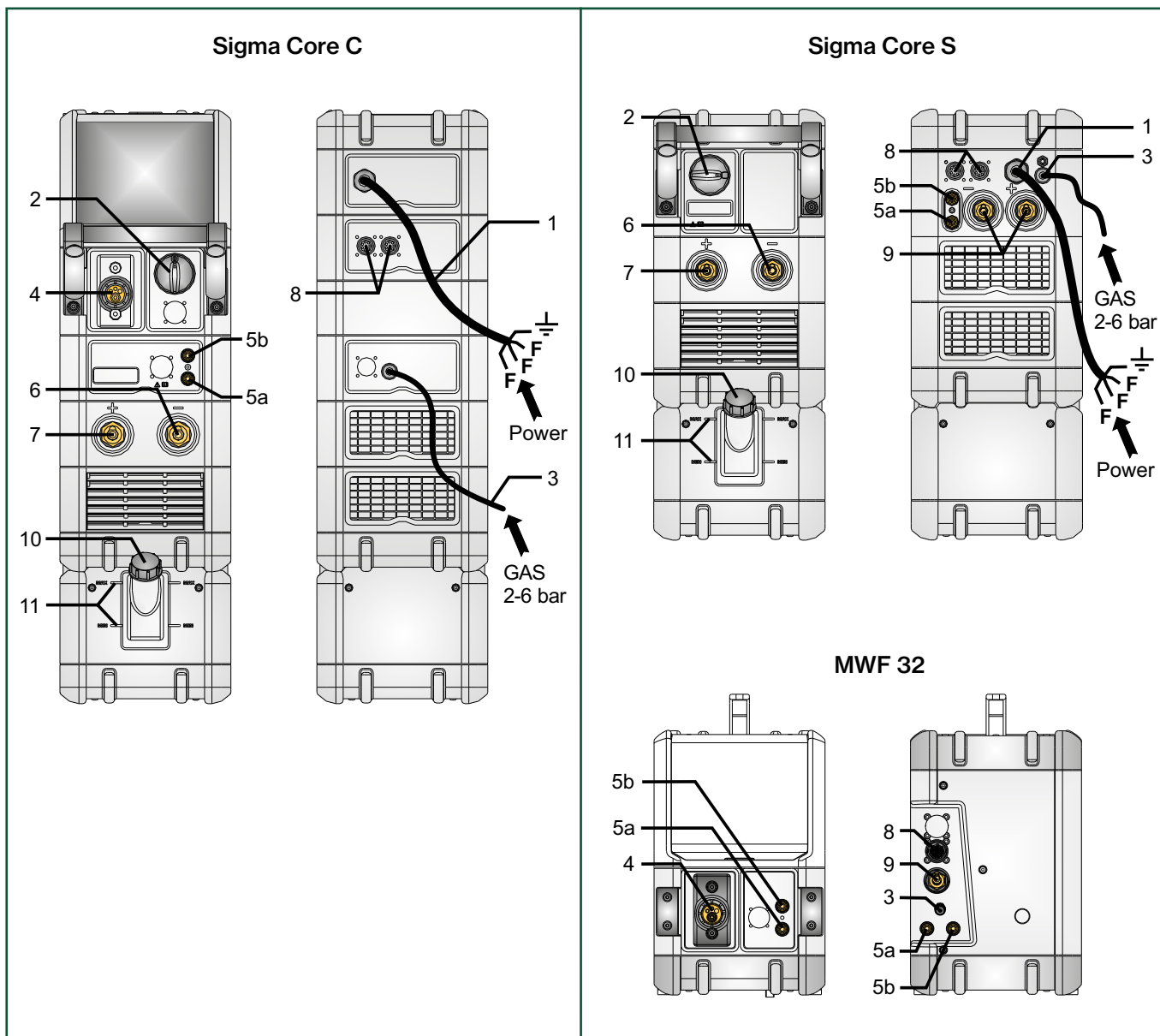

1. Netaansluiting
2. Hoofdschakelaar on/off
3. Aansluiting van het beschermgas
4. Aansluiting van de lastoorts
- 5a. Aansluiting van de koelslang, aanvoerslang (blauw)
- 5b. Aansluiting van de koelslang, retourslang (rood)
6. Aansluiting van de aardklem (MIG) of de elektrodenhouder (MMA)
7. Aansluiting van de aardklem (MMA) of de elektrodenhouder (MMA)
8. CAN verbinding en MWF voeding
9. Aansluiting tussenpakket
10. Bijvullen van de koelvloeistof
11. Peilen van het koelvloeistofniveau (Min/Max)

Aansluiting en bediening



Waarschuwing

Lees de waarschuwingen en deze gebruikershandleiding zorgvuldig door voordat u de apparatuur aansluit en in gebruik neemt en bewaar de informatie eventueel voor gebruik later.

Toegestane installatie

Netaansluiting

Sluit de machine op de juiste netvoeding aan. Lees ook het typeplaatje (U₁) aan de achterkant van de machine.

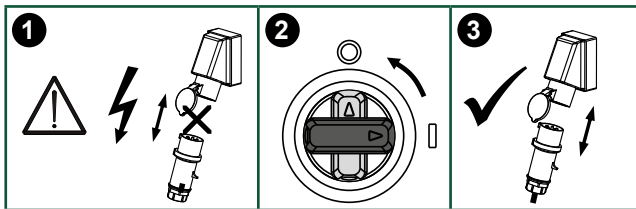
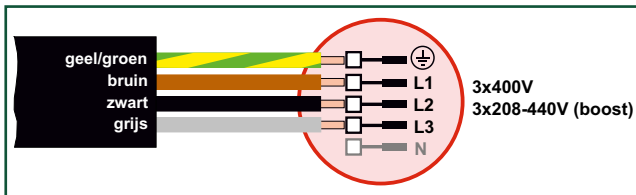

Voltage Stabilisatie kit

De stroombron is configureerbaar met een spanningsstabilisatie kit ter beveiliging tegen grotere spanningsvariaties, bijvoorbeeld bij gebruik van een generator wanneer de machine is aangesloten op een aparte voeding.

Aansluiting van het beschermgas

De gas slang wordt aangesloten op het achterpaneel van de stroombron (3), en verbonden met de gasvoorziening met een gasdruk van 2-6 bar. (Opmerking: sommige soorten drukregelaars vereisen een uitgang gasdruk van meer dan 2 bar om optimaal te functioneren). Een/twee gascilinders kunnen geplaatst worden op de flessendrager aan de achterkant van het onderstel.

Gasverbruik

Afhankelijk van het te lassen product, gassoort en ontwerp van de lasnaad, zal het gasverbruik variëren van 6-7 l/min bij lage ampèrage (<25A) tot 27 l/min bij maximale ampèrage.

Materiaalverbruik

Materiaalverbruik (gewicht) kan worden geschat door het product te berekenen van de lastijd (min), de draaddoorvoersnelheid (m/min) en het gewicht per meter van de gebruikte lasdraad.

Aansluiting laskabel bij MMA

De las- en aardkabel moeten worden aangesloten op resp. de zitting + (10) en - (8). Raadpleeg de instructies van de elektrodenleverancier bij het selecteren van polariteit.

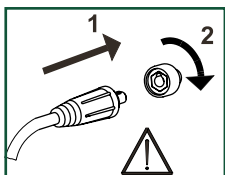

Belangrijk!

Om, wanneer aardkabels en lastoortsen aan de machine worden aangesloten, schade aan pluggen en kabels te voorkomen, is een goed elektrisch contact vereist. (zie tekening).

Lastoorts aansluiten

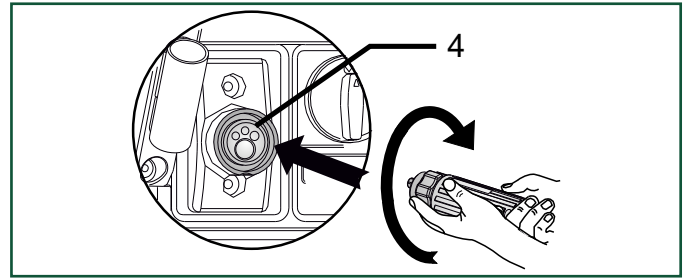

Aanbevolen kabeldiktes

Lasroom	DC	PULS
200 A	35 mm ²	35 mm ²
300 A	50 mm ²	70 mm ²
400 A	95 mm ² / 2x50 mm ²	95 mm ² / 2x50 mm ²
550 A	2x70 mm ²	2x70 mm ²

Lasproces	Afstand tot werkstuk (a+b)	Totale kabel lengte van het lascircuit (a+b+c)
MIG - puls	10 m	20 m
MIG - geen puls	30 m	60 m

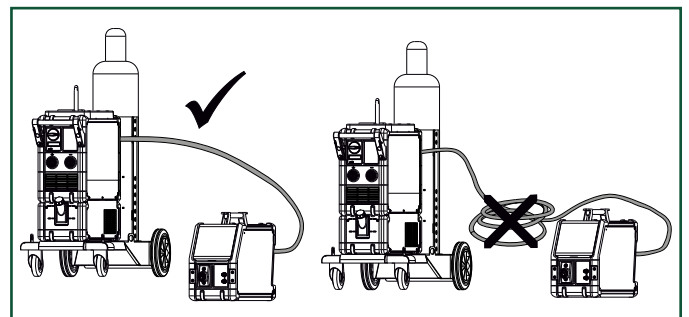
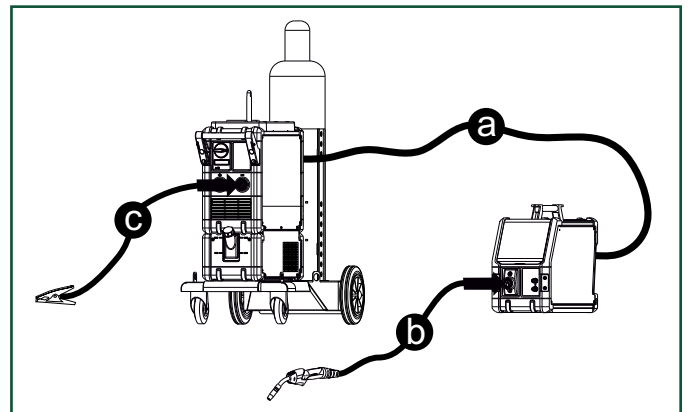

WAARSCHUWING

Als de schakelaar van de lastoorts wordt ingedrukt, komt de lasdraad/elektrode onder spanning te staan.

Aansluiting en bediening

Hefinstructies

Het hefpunt moet gebruikt worden zoals aangegeven in de volgende tekening. De machine mag niet worden opgetild wanneer er een gasfles is aangesloten. (Zie tekening).

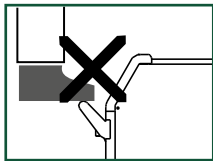
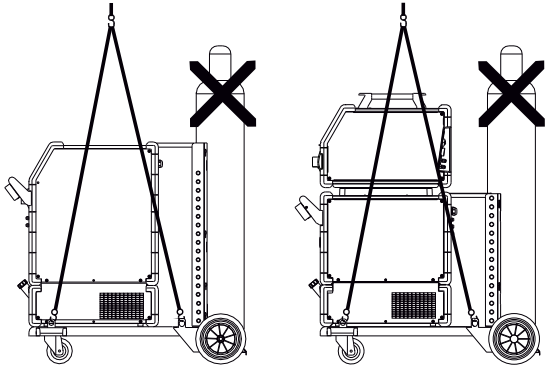

Til de machine niet op met de handgreep. Ga niet op de handgreep staan.

Afstellen van draadhaspelrem

De draadrem moet ervoor zorgen dat de draadhaspel voldoende afremt om te voorkomen dat de draad van de haspel afloopt. De remkracht is afhankelijk van het gewicht van de haspel en de draadsnelheid. De fabrieksinstelling is 15 kg.

Afstellen:

- Verwijder de regelknop door een dunne schroevendraaier achter de knop te plaatsen en deze er vervolgens uit te duwen.
- Stel de draadrem af door de zelfborgende moer op de as van de haspelhouder vaster of losser te draaien.
- Druk de knop terug.

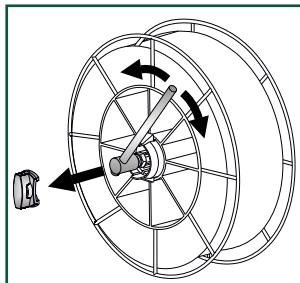

Draadvoer

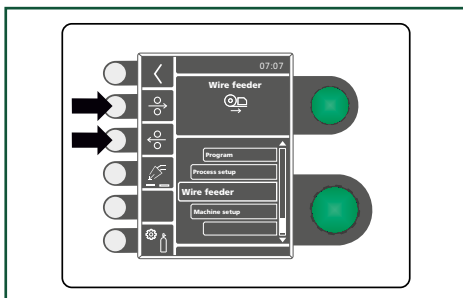
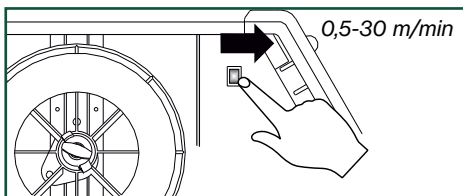

MCU ventilatie

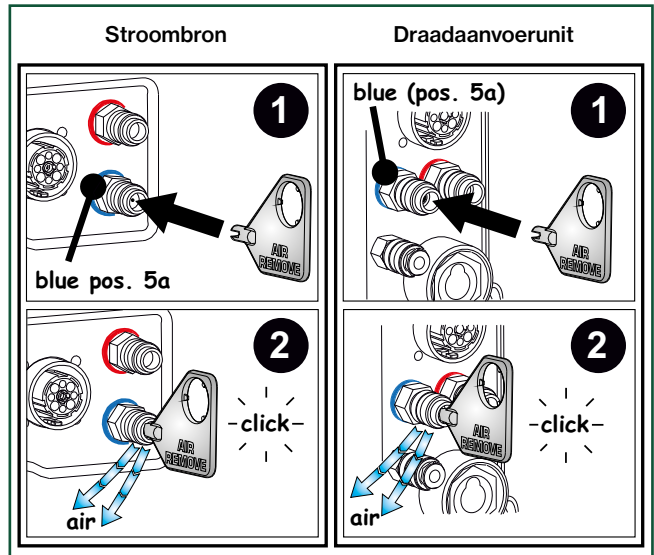

MWF sluit-draaifunctie

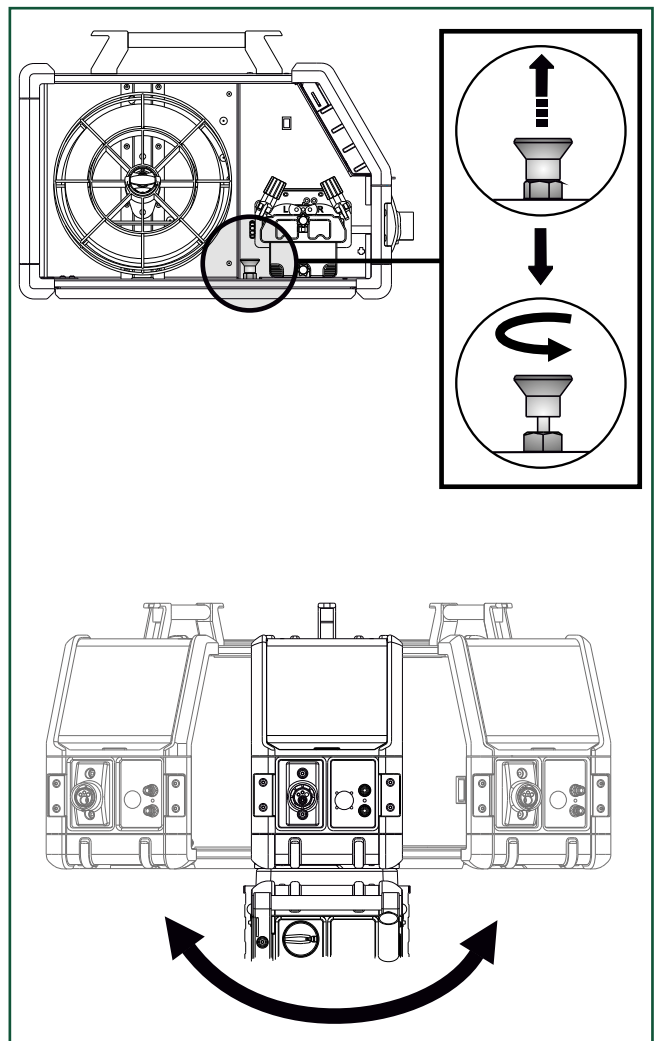

Aansluiting en bediening

Assemblen van onderdelen in de draadaanvoerunit

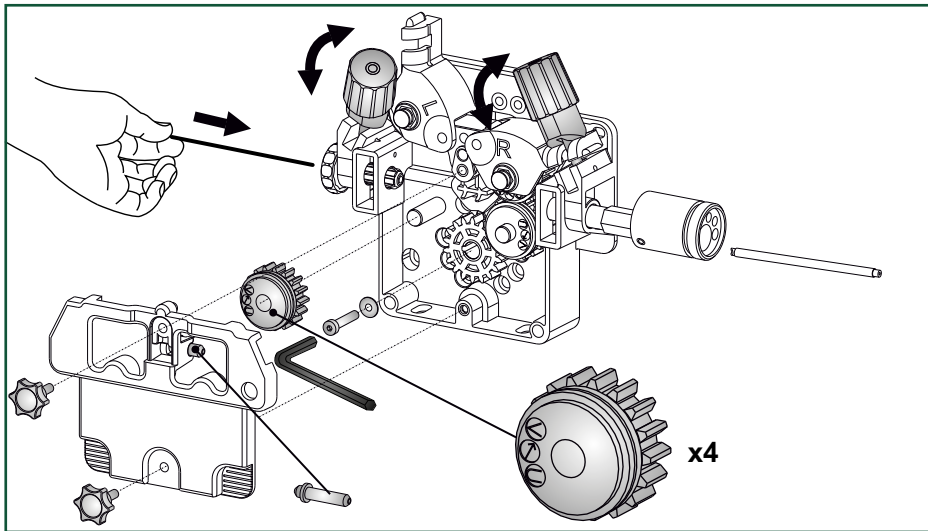

Met behulp van de kartelmoer op de spanbout wordt de druk op de transportrollen dusdanig ingesteld, dat een gelijkmatige draadaanvoer wordt bewerkstelligt zonder vervorming van de draad.

Software update

- Schuif de SD-kaart in.
- Schakel de machine in.
- Wacht tot de unit aangeeft dat de update gereed is.
- Schakel de machine uit en verwijder de SD kaart.
- De machine is nu klaar voor gebruik.

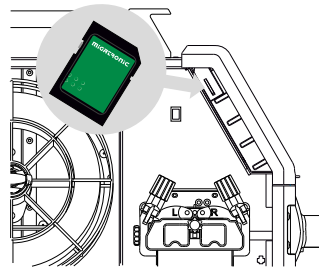

Nieuwe software wordt geladen in de krachtbron en alle aangesloten units.

De software kan worden gedownload via <http://migatronic.com> naar een SD-kaart. Het bestandssysteem van de SD-kaart moet worden geformatteerd naar FAT32.

BELANGRIJK:

Sla de software op in de //MIGA_SW/SIGMA/ bestandsstructuur.

Speciale functies

Software / Licenties

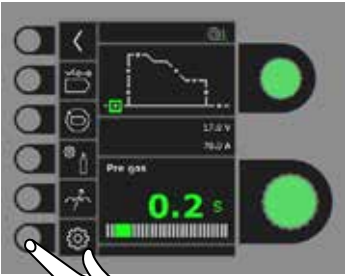
I 

II 

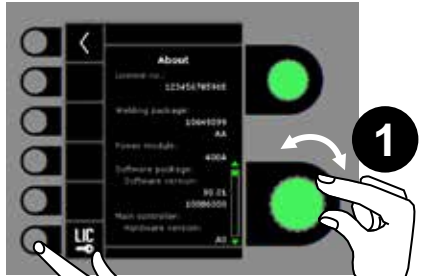
III 

Kabellengte compensatie (kalibratie van de weerstand van het stroomcircuit)

I 

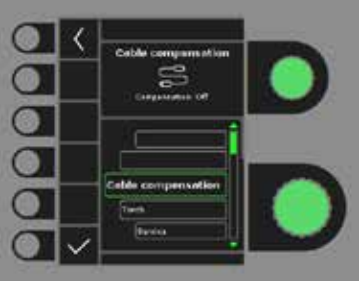
II 

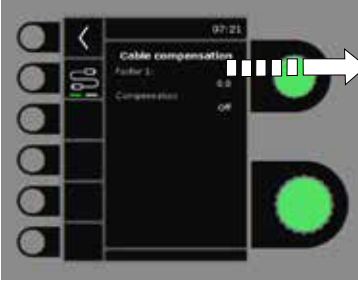
III 

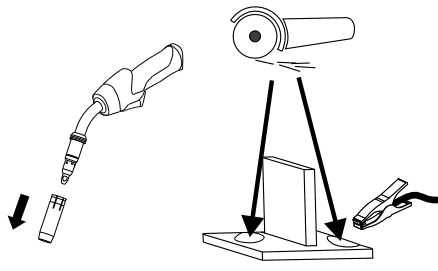
IV 

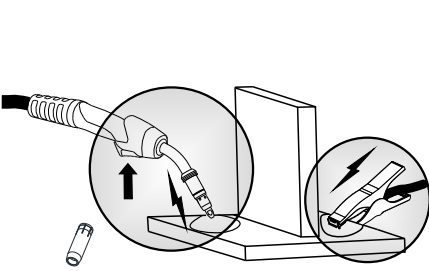
V 

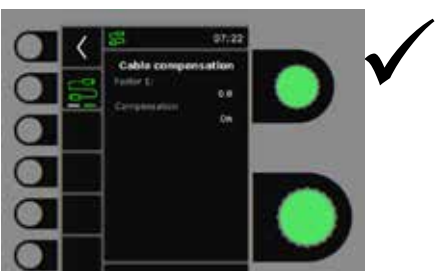
VI 

! Het oppervlakte van het werkstuk dient schoon te zijn, om verzekerd te zijn van goed contact met de toorts.

 = Kabelcompensatie geactiveerd

Speciale functies

Kalibratie van gasflow (niet alle modellen)

<p>I</p>	<p>II</p>	<p>III</p>
<p>IV</p>	<p>V</p>	

Toortsinstelling

<p>I</p>	<p>II</p>	<p>III</p>
<p>IV</p>		

Omgaan met fouten

SIGMA CORE heeft een ingebouwd geavanceerd zelfbeschermingssysteem. De machine stopt automatisch de gastoevoer, onderbreekt de lasstroom en stop de draadaanvoer in geval van een foutmelding.

Geselecteerde fouten:



Toortskoelfout

Koelfoutindicator licht op door verkeerde aansluiting of een verstopping er geen circulatie van het koelvloeistof plaatsvindt. Controleer of de koelsslangen juist zijn aangesloten, voldoende koelvloeistof aanwezig is, en controleer de lastoorts of aanverwante slangen. De koelfout wordt opgeheven door kort de ✓-knop in te drukken.

Gasstoring (IGC)

Een gasfout is te wijten aan een te lage of te hoge gasflow. Overtuig u ervan dat de druk op de gasflow hoger is dan 2 bar en minder dan 6 bar, want overeenkomt met resp. 5 l/min en 27 l/min. Deze foutmelding wordt uitgeschakeld door de handmatige gasflow af te stellen op 27 l/min. De gasfout wordt gereset door kort op het ✓-knop te drukken.

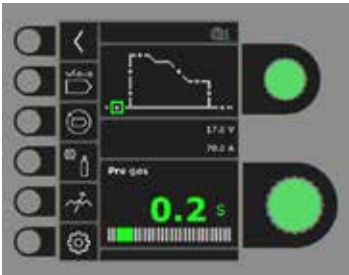
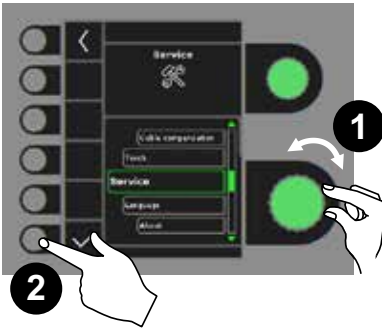
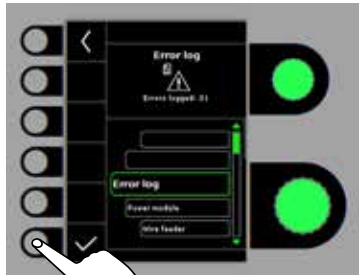
Let op: Het is belangrijk dat de ingestelde gastoevoer tijdens het lassen blijft gehandhaafd.

Foutenlog		
<p>I</p> 	<p>II</p> 	<p>III</p> 
<p>IV</p> <p>Foutenlog Alle fouten worden in de foutenlog van de machine in het menu Service opgeslagen. De foutenlog kan worden gedistribueerd door een SD-kaart te plaatsen en op het volgende keypad te drukken: De foutenlog is nu op de SD-kaart opgeslagen. De foutenlog kan worden gereset door op het keypad met de vuilnisbak te drukken.</p>		

Technische gegevens 1

STROOMBRON	300		400		550	
Aansluitspanning $\pm 15\%$ (50-60Hz), V	3x400		3x400		3x400	
Minimale capaciteit aggregaat, kVA	16		27		40	
¹ Minimaal kortsluitvermogen Ssc, MVA	3,7		6,0		9,5	
Netzekering, A	16		20		35	
Netstroom effectief, A	10,5		17,5		27,2	
Netstroom max., A	15,4		26,0		39,2	
Opgenomen vermogen, (100%), kVA	9,0		12,1		18,9	
Opgenomen vermogen, max., kVA	10,7		18,0		27,1	
Vermogen open spanning, W	11		12		12	
Rendement, %	87		89		90	
Stroomfactor	0,90		0,90		0,90	
	MIG	MMA	MIG	MMA	MIG	MMA
Stroombereik, A	15-300	15-250	15-400	15-400	15-550	15-550
100% inschakelduur 20°C, A	290/28,5	250/30,0	345/31,5	345/33,8	475/37,8	475/39,0
Max. inschakelduur 20°C, A/%/V			400/65/34,0	400/65/36,0	550/60/41,5	550/60/42,0
100% inschakelduur 40°C, A/V	220/25,0	210/28,4	300/29,0	300/32,0	430/35,5	430/37,2
60% inschakelduur 40°C, A/V	230/25,5	220/28,8	370/32,5	370/34,8	510/39,5	510/40,4
Max. inschakelduur 40°C, A/%/V	300/25/29,0	250/35/30,0	400/50/34,0	400/45/36,0	550/50/41,5	550/50/42,0
Open spanning, V	50-60		65-75		75-80	
² Gebruikersklasse	S/CE		S/CE		S/CE	
³ Beschermingsklasse	IP23S		IP23		IP23	
Norm, C	IEC60974-1, IEC60974-5, IEC60974-10 Cl. A					
Norm, S	IEC60974-1, IEC60974-10 Cl. A					
Afmetingen C (HxBxL), mm	700x260x735		700x260x735		700x260x735	
Afmetingen S (HxBxL), mm	454x260x735		454x260x735		454x260x735	
Gewicht C / S, kg	36,9 / 26		52 / 35		53 / 36	

STROOMBRON	300 Boost				400 Boost			
Aansluitspanning $\pm 10\%$ (50-60Hz), V	3x208-380		3x380-440		3x208-380		3x380-440	
Minimale capaciteit aggregaat, kVA	16		16		25		25	
¹ Minimaal kortsluitvermogen Ssc, MVA	1,7		3,75					
Netzekering, A	20		16		25-50		25-50	
Netstroom effectief, A	19,5		10,6		22,0		11,7	
Netstroom max., A	31,6		16,2		45,0		23,5	
Opgenomen vermogen, (100%), kVA	7,1		7,0		8,3		8,1	
Opgenomen vermogen, max., kVA	11,0		10,6		16,7		16,3	
Vermogen open spanning, W	45		16		60		56	
Rendement, %	82		87		84		88	
Stroomfactor	0,95		0,95		0,96		0,95	
	MIG	MMA	MIG	MMA	MIG	MMA	MIG	MMA
Stroombereik, A	15-300	15-250	15-300	15-250	15-400	15-400	15-400	15-400
100% inschakelduur 20°C, A	250/26,5		250/26,5		300/29,0	300/32,0	300/29,0	300/32,0
Max. inschakelduur 20°C, A/%/V	300/40/29,0		300/40/29,0		400/30/34,0	400/30/32,0	400/30/34,0	400/30/32,0
100% inschakelduur 40°C, A/V	200/24,0	200/28,0	200/24,0	200/28,0	250/26,5	220/28,8	250/26,5	220/28,8
60% inschakelduur 40°C, A/V	210/24,5	210/28,4	210/24,5	210/28,4	280/28,0	260/30,4	280/28,0	260/30,4
Max. inschakelduur 40°C, A/%/V	300/25/29,0	250/35/30,0	300/25/29,0	250/35/30,0	400/25/34,0	400/20/36,0	400/25/34,0	400/20/36,0
Open spanning, V	50-60				70-75			
² Gebruikersklasse	S/CE				S/CE			
³ Beschermingsklasse	IP23S				IP23			
Norm, C	IEC60974-1, IEC60974-5, IEC60974-10 Cl. A				IEC60974-1, IEC60974-5, IEC60974-10 Cl. A			
Norm, S	IEC60974-1, IEC60974-10 Cl. A				IEC60974-1, IEC60974-10 Cl. A			
Afmetingen C (HxBxL), mm	700x260x735				900x260x735			
Afmetingen S (HxBxL), mm	454x260x735				654x260x735			
Gewicht C / S, kg	45 / 34				66 / 49			

- Deze apparatuur voldoet aan EN / IEC61000-3-12:2014 (/ 2011) op voorwaarde dat het kortsluitvermogen Ssc van de voeding bij het aansluitpunt groter is of gelijk is aan de gegevens zoals in bovenstaande tabel bevestigd is. Het is de verantwoordelijkheid van de installateur of de gebruiker van de installatie, om zich ervan te overtuigen, dat de apparatuur uitsluitend aangesloten is op een voeding met een kortsluitvermogen Ssc groter is of gelijk is aan de gegevens zoals in bovenstaande tabel bevestigd is. Indien nodig kan eea worden nagegaan bij de energieleverancier
- S** Deze machine voldoet aan de eisen gesteld aan machines die moeten werken in gebieden waar een verhoogd risico bestaat voor elektrische schokken
- De machine is ontworpen voor gebruik binnen en buiten volgens beschermingsklasse IP23/IP23S.
IP23S: De machine mag worden opgeslagen, maar is niet bedoeld om tijdens neerslag buiten te worden gebruikt, tenzij onder een beschutting.

Technische gegevens 2

DRAADTOEVOERKOFFER MWF	
Draadtoevoersnelheid, m/min	0,5-30,0
Toortsaansluiting	EURO
Diameter draadhaspel, mm	300
Draadhaspel, kg	5-18
100% inschakelduur 40°C, A/%	430
60% inschakelduur 40°C, A/%	500
Max. inschakelduur 40°C A/%	550/50
³⁾ Beschermingsklasse	IP23
Draaddiameter, mm	0,6-1,6
Gasdruk, MPa (bar)	0,6 (6,0)
Afmetingen (HxBxL), mm	457x260x672,5
Gewicht, kg	14,0
Norm	IEC60974-5, IEC60974-10 CL. A

KOELUNIT MCU 1300	
Koelvermogen (1 l/min), W	1300
Koelvermogen (1,5 l/min), W	1600
Inhoud tank, liter	5
Waterdoorstroom, bar - °C - l/min	3,0-60-1,5
Maximale druk, bar	5
Norm	IEC60974-2, IEC60974-10 CL.A
Afmetingen (HxBxL), mm	207x260x680
Gewicht	20

VERKLARING VAN OVEREENSTEMMING



MIGATRONIC A/S
Aggersundvej 33
9690 Fjerritslev
Denmark

Verklaart dat onderstaande machine

Type: SIGMA CORE

voldoet aan richtlijn: 2014/35/EU
2014/30/EU
2011/65/EU

Europese standaarden: EN IEC60974-1:2018/A1:2019
EN IEC60974-2:2019
EN IEC60974-5:2019
EN IEC60974-10:2014/A1:2015

Regelgeving: 2019/1784/EU

Fjerritslev 01.10.2022

Kristian M. Madsen
CEO

- Deze apparatuur voldoet aan EN / IEC61000-3-12:2014 (/ 2011) op voorwaarde dat het kortsluitvermogen Ssc van de voeding bij het aansluitpunt groter is of gelijk is aan de gegevens zoals in bovenstaande tabel bevestigd is. Het is de verantwoordelijkheid van de installateur of de gebruiker van de installatie, om zich ervan te overtuigen, dat de apparatuur uitsluitend aangesloten is op een voeding met een kortsluitvermogen Ssc groter is of gelijk is aan de gegevens zoals in bovenstaande tabel bevestigd is. Indien nodig kan eea worden nagegaan bij de energieleverancier
- S** Deze machine voldoet aan de eisen gesteld aan machines die moeten werken in gebieden waar een verhoogd risico bestaat voor elektrische schokken
- De machine is ontworpen voor gebruik binnen en buiten volgens beschermingsklasse IP23/IP23S.
IP23S: De machine mag worden opgeslagen, maar is niet bedoeld om tijdens neerslag buiten te worden gebruikt, tenzij onder een beschutting.

KytKentä ja käyttö

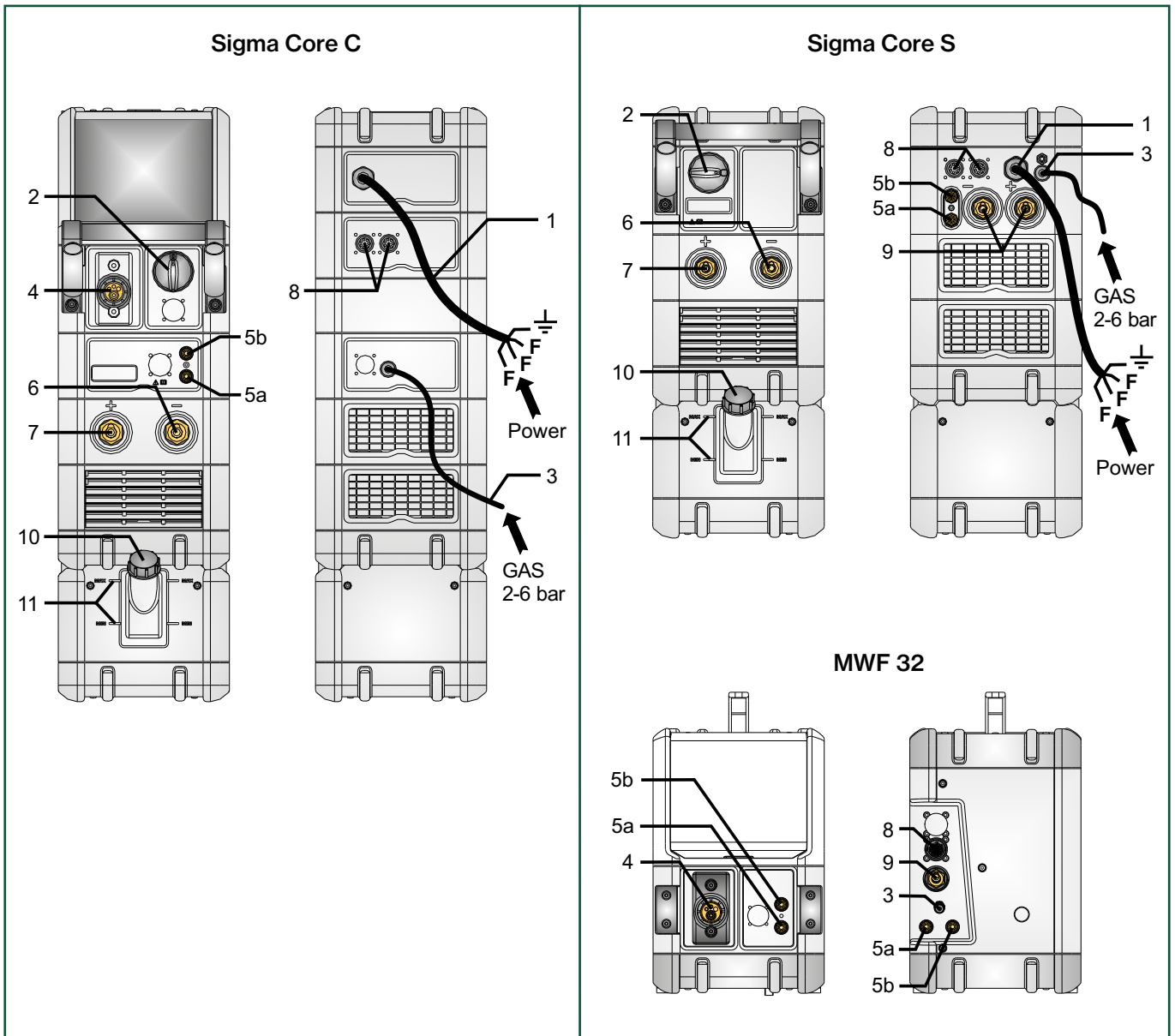

1. LiitÄntÄ sÄhköverkkoon
2. PÄÄlle/pois -kytkin
3. Suojakaasun liitÄntÄ
4. Hitsauspolttimen liitin
- 5a. JÄähdytysletkun liitÄntÄ, virtaus (sininen)
- 5b. JÄähdytysletkun liitÄntÄ, paluu (punainen)
6. Maakaapelin (MIG) tai puikkokaapelin liitÄntÄ (MMA)
7. Maakaapelin (MMA) tai puikkokaapelin liitÄntÄ (MMA)
8. CAN -liitÄntÄ ja MWF syöttö
9. VÄlikaapelin liitÄntÄ
10. JÄähdytysnesteen lisÄys
11. JÄähdytysnesteen nÄyttö (Min/Max)

KytKentä ja käyttö



Varoitus

Lue huolellisesti nämä varoitukset sekä käyttöohje, ennen kuin otat koneen käyttöön. Säilytä käyttöohje myöhempää käyttöä varten.

Luvallinen asennus

Liittäminen sähköverkkoon

Tarkista koneen takaa arvokilvestä, mikä on oikea verkkojännite.

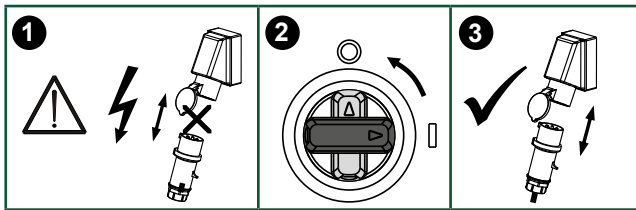
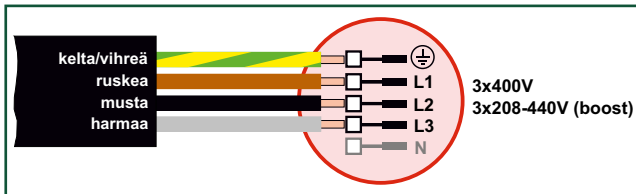

Jännitteen vakauttamissarja

Virtalähde on konfiguroitavissa jännitteen vakautussarjalla, suojana suuremmilta jännitteen vaihteluilta, esim. Generaattorikäytössä, jossa hitsauskone on kytketty erilliseen virtalähteeseen.

Suojakaasun liittäminen

Virtalähteen takapaneelista lähtevä suojakaasuletku (3) liitetään kaasunlähteeseen paine laskettuna 2-6 bariin. (Huomaa: Jotkin paineensäädintyyppit vaativat yli 2 barin ulostulopaineen toimiakseen optimaalisesti). Kaasupullo/kaasupullot pitää asentaa koneen taakse kaasupulloalustalle sidottuna siellä olevilla liinoilla.

Kaasun kulutus

Hitsaustehtävästä, kaasutyypistä ja hitsisauman rakenteesta riippuen kaasunkulutus vaihtelee välillä 6-7 l/min pienillä hitsausvirroilla (<25A) ja jopa 27 l / min max. hitsausvirroilla.

Materiaalin kulutus

Materiaalikulutus voidaan arvioida laskemalla hitsausaika minuuteissa kertaa langansyöttönopeus (m / min) kertaa käytetyn hitsauslisäaineen paino / metri.

Puikontipin kytKentä puikkohitsausta varten

Puikontidin ja paluuvirtakaapeli kytketään plusliittimeen (10) ja miinusliittimeen (8). Noudata hitsauspuikkovalmistajan ohjeita valitessasi napaisuutta.

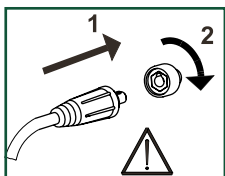

Tärkeää!

Kiinnitä huolellisesti maakaapeli ja hitsauspoltin. Liittimet ja kaapeli voivat muuten vaurioitua.

Hitsauspolttimen asennus

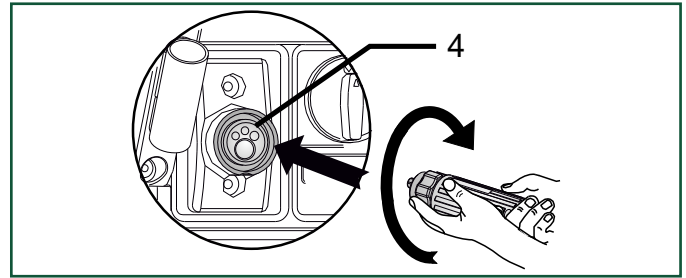

Suosittelut kaapeleiden mitat

Hitsausvirta	DC	PULSSI
200 A	35 mm ²	35 mm ²
300 A	50 mm ²	70 mm ²
400 A	95 mm ² / 2x50 mm ²	95 mm ² / 2x50 mm ²
550 A	2x70 mm ²	2x70 mm ²

Hitsausprosessi	Etäisyys työkappaleeseen (a+b)	Kaapeleiden kokonaispituus hitsauspiirissä (a+b+c)
MIG - pulssi	10 m	20 m
MIG - ilman pulssia	30 m	60 m

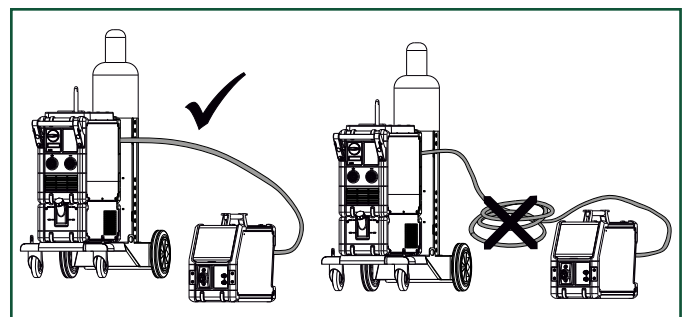
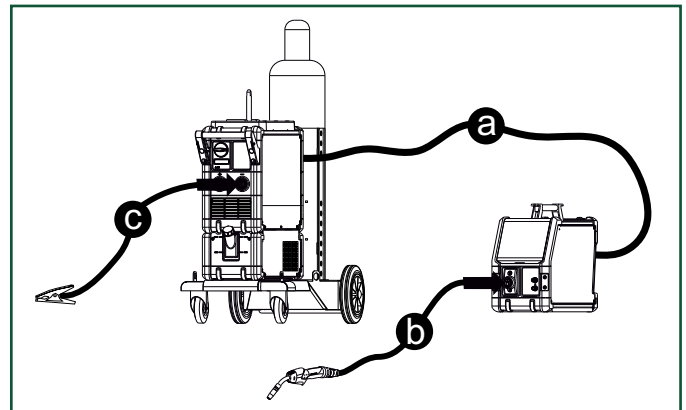

VAROITUS

Hitsauslanka/elektrodi on jännitteellinen, kun polttimen liipaisimesta painetaan.

KytKentä ja käyttö

Nosto-ohjeet

Konetta nostettaessa on ehdottomasti käytettävä alla olevan kuvan mukaisia nostopisteitä. Konetta ei saa nostaa kaasupullon ollessa kytkettynä laitteeseen.

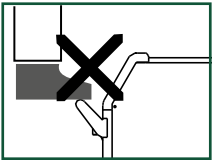
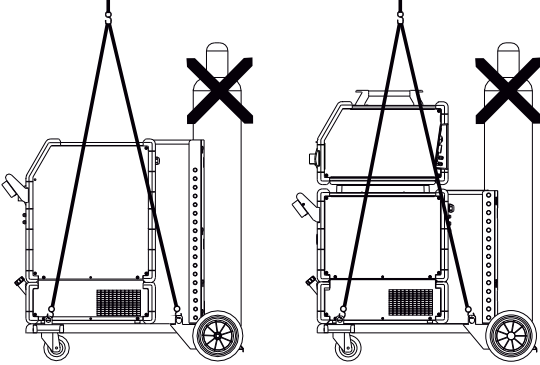

Älä nosta hitsauskonetta kädensijasta.
Älä astu kädensijan päälle.

Lankajarrun säätö

Jarru pitää säätää niin lujaa, että lankakela pysähtyy, ennen kuin lanka tulee kelan yli ja sotkeutuu. Jarrun kireys riippuu lankakelan painosta ja lankanopeudesta. Tehdasasetus = 15 kg.

Säätö:

- Irrota säätönuppi asettamalla ohut ruuvimeisseli nupin taakse, minkä jälkeen voit vetää sen pois.
- Säädä jarru kiristämällä tai löysäämällä lankakelan napa-akselin itselukitsevaa mutteria.
- Nuppi pitää jälleen asentaa paikoilleen.

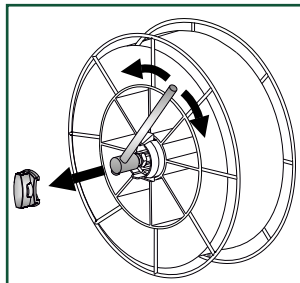

Langansyöttäminen

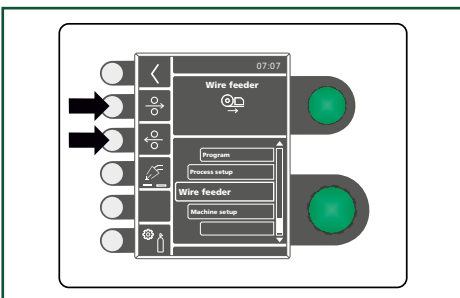
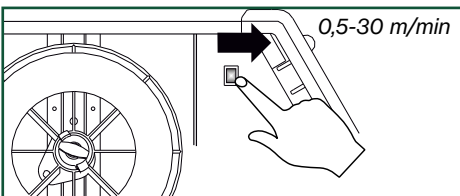

MCU vedenkiertolaitteen ilmaus

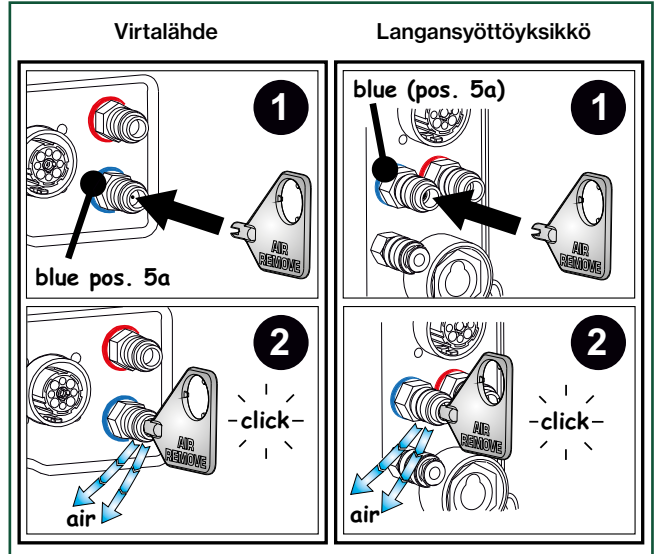

MWF käynnön lukitustoiminto

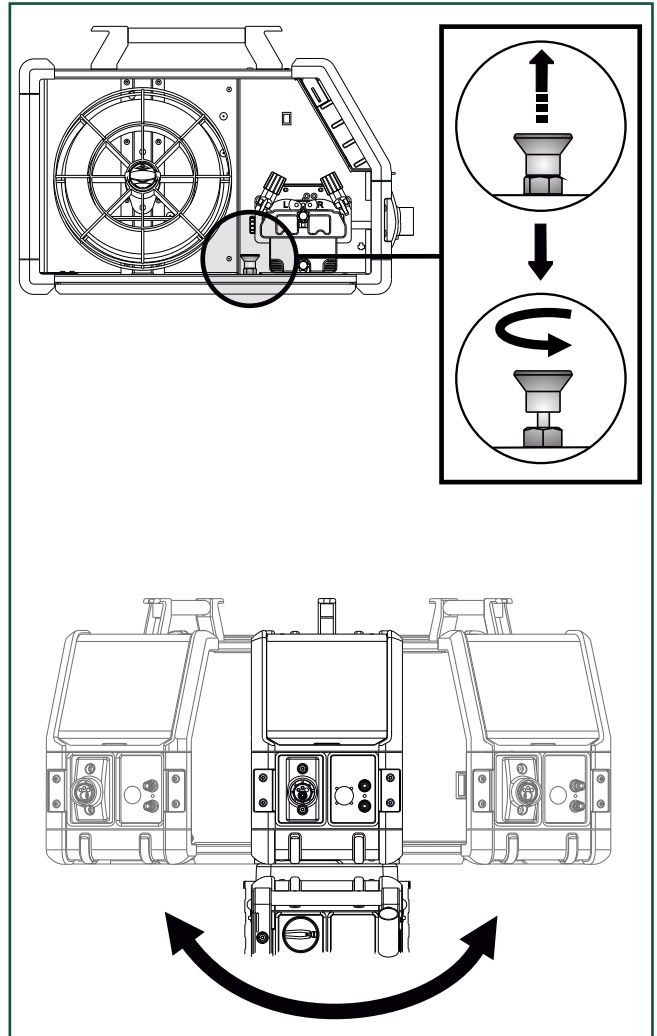

KytKentä ja käyttö

Osien asennus langansyöttölaiteeseen

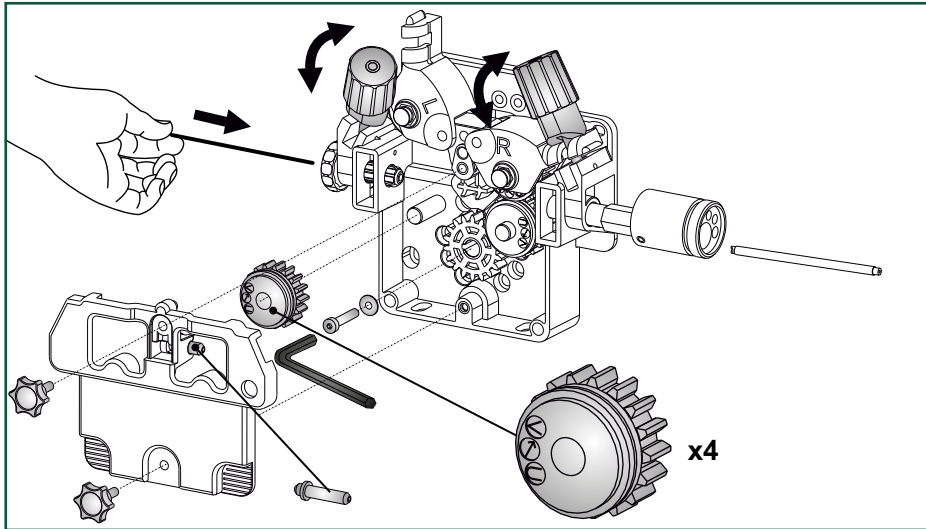

Säädä syöttöpöörrien paine siten, että se juuri ja juuri liukuu langan päällä, kun tämä pysäytetään kontaktisuuttimen kohdalla

Ohjelman päivittäminen

- Aseta SD-kortti.
- Kone käynnistetään tämän jälkeen.
- Odota, kunnes yksikkö ilmoittaa, että päivitys on valmis.
- Kone pitää jälleen sammuttaa kytkimestä ja SD-kortti poistaa.
- Kone on käyttövalmis.

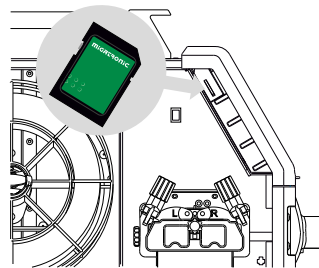

Uusi ohjelmisto ladataan virtalähteeseen ja kaikkiin liitettyihin laitteisiin.

Ohjelman voi ladata myös <http://migatron.com> SD-kortille. SD-kortin tiedostojärjestelmä on alustettava FAT32-muotoon.

TÄRKEÄ:

Tallenna ohjelmisto //MIGA_SW/SIGMA/ tiedostorakenteeseen.

Erikoistoiminnot

Ohjelmistot / Lisenssit

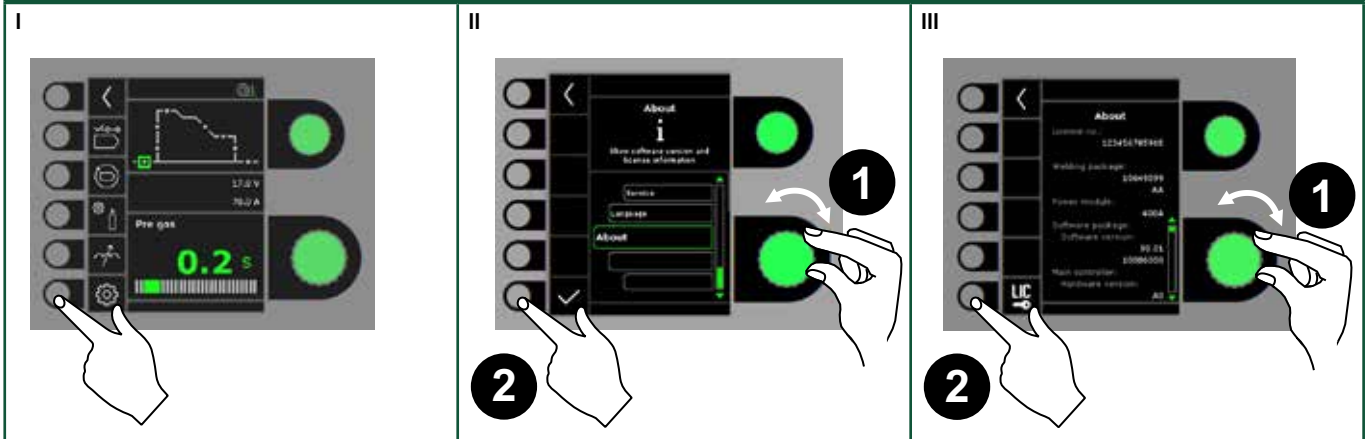

Kaapelikompensatio (Hitsauskaapelin vastuksen kalibrointi)

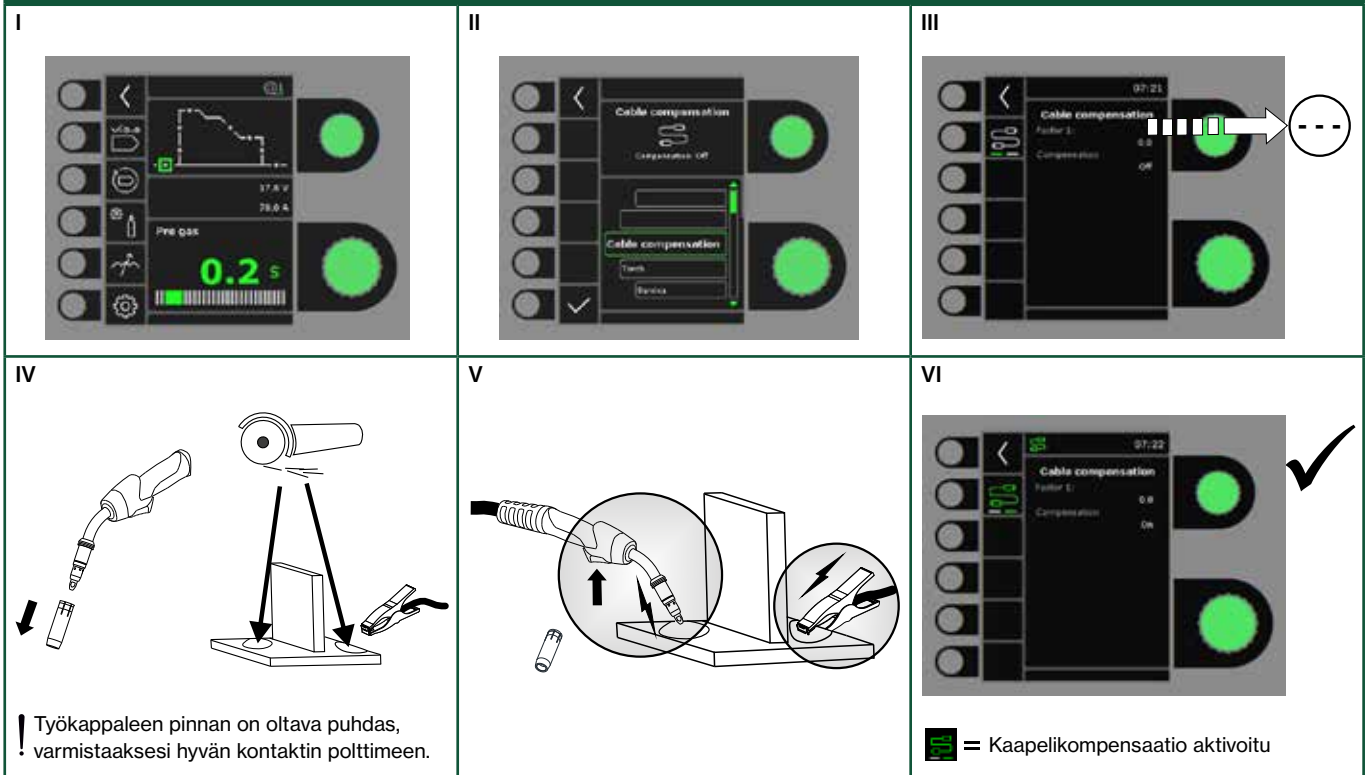

Erikoistoiminnot

Kaasuvirtauksen kalibrointi (ei kaikissa malleissa)

<p>I</p>	<p>II</p>	<p>III</p>
<p>IV</p>	<p>V</p>	

Polttimen asetus

<p>I</p>	<p>II</p>	<p>III</p>
<p>IV</p>		

Virheiden käsittely

SIGMA CORE on pitkälle kehitetty sisäinen suojausjärjestelmä. Vian ilmetessä kone keskeyttää kaasun ja virran syötön sekä pysäyttää langansyötön automaattisesti.

Havaittu vika:

Vika hitsauspolttimen jäädytyksessä



Virtauksenvarijalla (water flow kit) varustetussa hitsauskoneessa vikakoodi osoittaa viallisen liitännän tai letkuntukkeutumisen siinä tapauksessa, että jäähdytysneste ei pääse virtaamaan. Tarkista jäähdytysletkujen kiinnitykset ja liitännät, täytä vesisäiliö ja tarkista hitsausletku haaroineen. Lyhyt painallus ✓-näppäimellä poistaa vikakoodin.

Vika kaasunsyötössä (IGC)

Kaasuvirtaus on liian vähäinen tai liian suuri. Varmista, että kaasuvirran paine on yli 2 bar ja alle 6 bar, vastaten arvoja 5 l/min ja 27 l/min. Kaasuvirhe saadaan pois toiminnasta säätämällä kaasuvirtaus manuaalisesti arvoon 27 l/min.

Kaasuvirhe poistuu lyhyellä painalluksella ✓-näppäimestä.

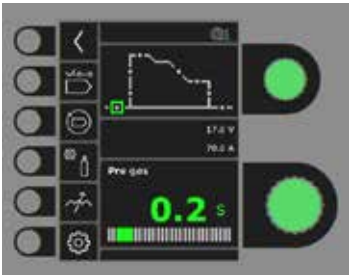
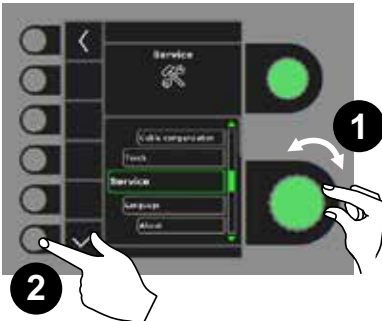
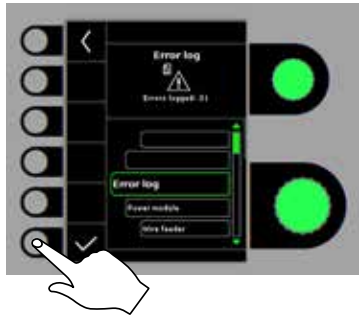
Huomio: On tärkeää, että asetettu kaasunsyöttö voidaan säilyttää hitsauksen aikana.

Vikalista		
<p>I</p> 	<p>II</p> 	<p>III</p> 
<p>IV</p> <p>Vikalista</p> <p>Kaikki toimintahäiriöt on tallennettu koneen Menu Service -valikkoon. Vikalistan voi tallentaa SD-kortille painamalla allaolevaa näppäintä. Vikaluettelo on nyt tallennettu. Vikaluettelo voidaan poistaa "roskakoriin" asettamalla luku nolleen ja painamalla näppäintä.</p>		

Tekniset tiedot 1

VIRTALÄHDE	300		400		550	
Verkköjännite ±15% (50-60Hz), V	3x400		3x400		3x400	
Minimi generaattorin koko, kVA	16		27		40	
¹ Minimi oikosulkuteho Ssc, MVA	3,7		6,0		9,5	
Sulake, A	16		20		35	
Verkkovirta tehollinen, A	10,5		17,5		27,2	
Maksimiverkkovirta, A	15,4		26,0		39,2	
Kulutus 100%, kVA	9,0		12,1		18,9	
Kulutus max., kVA	10,7		18,0		27,1	
Tyhjäkäyntikulutus, W	11		12		12	
Hyötysuhde, %	87		89		90	
Tehokerroin	0,90		0,90		0,90	
	MIG	MMA	MIG	MMA	MIG	MMA
Virta-alue, tasavirta, A	15-300	15-250	15-400	15-400	15-550	15-550
Kuormitettavuus 100% 20°C, A	290/28,5	250/30,0	345/31,5	345/33,8	475/37,8	475/39,0
Kuormitettavuus maksimi 20°C, A/%V			400/65/34,0	400/65/36,0	550/60/41,5	550/60/42,0
Kuormitettavuus 100% 40°C, A/V	220/25,0	210/28,4	300/29,0	300/32,0	430/35,5	430/37,2
Kuormitettavuus 60% 40°C, A/V	230/25,5	220/28,8	370/32,5	370/34,8	510/39,5	510/40,4
Kuormitettavuus maksimi 40°C, A/%V	300/25/29,0	250/35/30,0	400/50/34,0	400/45/36,0	550/50/41,5	550/50/42,0
Tyhjäkäyntijännite, V	50-60		65-75		75-80	
² Käyttöluokka	S/CE		S/CE		S/CE	
³ Suojausluokka	IP23S		IP23		IP23	
Standardit, C	IEC60974-1, IEC60974-5, IEC60974-10 Cl. A					
Standardit, S	IEC60974-1, IEC60974-10 Cl. A					
Mitat C (KxLxP), mm	700x260x735		700x260x735		700x260x735	
Mitat S (KxLxP), mm	454x260x735		454x260x735		454x260x735	
Paino C / S, kg	36,9 / 26		52 / 35		53 / 36	

VIRTALÄHDE	300 Boost				400 Boost			
Verkköjännite ±10% (50-60Hz), V	3x208-380		3x380-440		3x208-380		3x380-440	
Minimi generaattorin koko, kVA	16		16		25		25	
¹ Minimi oikosulkuteho Ssc, MVA	1,7		3,75					
Sulake, A	20		16		25-50		25-50	
Verkkovirta tehollinen, A	19,5		10,6		22,0		11,7	
Maksimiverkkovirta, A	31,6		16,2		45,0		23,5	
Kulutus 100%, kVA	7,1		7,0		8,3		8,1	
Kulutus max., kVA	11,0		10,6		16,7		16,3	
Tyhjäkäyntikulutus, W	45		16		60		56	
Hyötysuhde, %	82		87		84		88	
Tehokerroin	0,95		0,95		0,96		0,95	
	MIG	MMA	MIG	MMA	MIG	MMA	MIG	MMA
Virta-alue, tasavirta, A	15-300	15-250	15-300	15-250	15-400	15-400	15-400	15-400
Kuormitettavuus 100% 20°C, A	250/26,5		250/26,5		300/29,0	300/32,0	300/29,0	300/32,0
Kuormitettavuus maksimi 20°C, A/%V	300/40/29,0		300/40/29,0		400/30/34,0	400/30/32,0	400/30/34,0	400/30/32,0
Kuormitettavuus 100% 40°C, A/V	200/24,0	200/28,0	200/24,0	200/28,0	250/26,5	220/28,8	250/26,5	220/28,8
Kuormitettavuus 60% 40°C, A/V	210/24,5	210/28,4	210/24,5	210/28,4	280/28,0	260/30,4	280/28,0	260/30,4
Kuormitettavuus maksimi 40°C, A/%V	300/25/29,0	250/35/30,0	300/25/29,0	250/35/30,0	400/25/34,0	400/20/36,0	400/25/34,0	400/20/36,0
Tyhjäkäyntijännite, V	50-60				70-75			
² Käyttöluokka	S/CE				S/CE			
³ Suojausluokka	IP23S				IP23			
Standardit, C	IEC60974-1, IEC60974-5, IEC60974-10 Cl. A				IEC60974-1, IEC60974-5, IEC60974-10 Cl. A			
Standardit, S	IEC60974-1, IEC60974-10 Cl. A				IEC60974-1, IEC60974-10 Cl. A			
Mitat C (KxLxP), mm	700x260x735				900x260x735			
Mitat S (KxLxP), mm	454x260x735				654x260x735			
Paino C / S, kg	45 / 34				66 / 49			

- 1) Tämä virtalähde täyttää EN / IEC61000-3-12:2014 (/ 2011) standardin vaatimukset ehdolla, että sähköverkon oikosulkuteho Ssc on suurempi tai yhtä suuri kuin taulukossa mainituissa tiedoissa sähkönsyötön ja julkisen sähköverkon välisessä liityntäpisteessä. Sähköasentajan ja käyttäjän vastuulla on huolehtia tarvittaessa sähköjohdinkaljan avustuksella, että laite on kytketty vain sellaiseen sähkönsyöttöön, jonka oikosulkuteho on suurempi tai yhtä suuri kuin ilmoitettu arvo.
- 2) **S** Tämä kone täyttää ne vaatimukset, jotka koneilta vaaditaan työskennellessä alueilla, joilla on suuri sähköiskun vaara.
- 3) Kone on suunniteltu sisä- ja ulkokäyttöön suojausluokan IP23 / IP23S mukaisesti.
IP23S: Kone voidaan varustoida, mutta sitä ei ole tarkoitettu käytettäväksi ulkona sateen aikana, ellei sitä ole suojattu.

Tekniset tiedot 2

LANGANSYÖTTÖYKSIKKÖ MWF	
Langansyöttönopeus, m/min	0,5-30,0
Pistoolin liitäntä	EURO
Lankakelan läpimitta, mm	300
Lankakela, kg	5-18
Kuorimittavuus 100 % 40°C, A/%	430
Kuorimittavuus 60% 40°C, A/%	500
Kuorimittavuus maksimi 40°C A/%	550/50
³⁾ Suojausluokka	IP23
Langan halkaisija, mm	0,6-1,6
Kaasun MPa (bar)	0,6 (6,0)
Mitat (KxLxP), mm	457x260x672,5
Paino, kg	14,0
Standardit	IEC60974-5, IEC60974-10 CL. A

JÄÄHDYTYSYKSIKKÖ MCU 1300	
Jäähdytysteho (1 l/min), W	1300
Jäähdytysteho (1,5 l/min), W	1600
Säiliön tilavuus, litraa	5
Virtaus, bar - °C - l/min	3,0-60-1,5
Maksimipaine, bar	5
Standardit	IEC60974-2, IEC60974-10 CL.A
Mitat (KxLxP), mm	207x260x680
Paino, kg	20

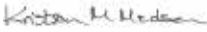
EU-KONFORMITÄTSEKTLÄRUNG	
CE	
Me,	MIGATRONIC A/S Aggersundvej 33 9690 Fjerritslev Dänemark
vakuutamme täten, että valmistamamme alla mainittu kone	
malli: SIGMA CORE	
täyttää direktiivien:	2014/35/EU 2014/30/EU 2011/65/EU vaatimukset.
Eurooppalaiset standardit:	EN IEC60974-1:2018/A1:2019 EN IEC60974-2:2019 EN IEC60974-5:2019 EN IEC60974-10:2014/A1:2015
Asetus:	2019/1784/EU
Fjerritslev 01.10.2022	
	
Kristian M. Madsen CEO	

- 1) Tämä virtalähde täyttää EN / IEC61000-3-12:2014 (/ 2011) standardin vaatimukset ehdolla, että sähköverkon oikosulkuteho Ssc on suurempi tai yhtä suuri kuin taulukossa mainituissa tiedoissa sähkönsyötön ja julkisen sähköverkon välisessä liityntäpisteessä. Sähköasentajan ja käyttäjän vastuulla on huolehtia tarvittaessa sähköjakelijan avustuksella, että laite on kytketty vain sellaiseen sähkönsyöttöön, jonka oikosulkuteho on suurempi tai yhtä suuri kuin ilmoitettu arvo.
- 2) **S** Tämä kone täyttää ne vaatimukset, jotka koneilta vaaditaan työskenneltäessä alueilla, joilla on suuri sähköiskun vaara.
- 3) Kone on suunniteltu sisä- ja ulkokäyttöön suojaluokan IP23 / IP23S mukaisesti.
IP23S: Kone voidaan varastoida, mutta sitä ei ole tarkoitettu käytettäväksi ulkona sateen aikana, ellei sitä ole suojattu.

DENMARK

Main office

MIGATRONIC A/S

Aggersundvej 33, DK-9690 Fjerritslev, Denmark
Tel. +45 96 500 600, www.migatron.com

MIGATRONIC AUTOMATION A/S

Knøsgårdvej 112, DK-9440 Aabybro, Denmark
Tel. +45 96 96 27 00, www.migatron-automation.com

MIGATRONIC EUROPE:

Great Britain

MIGATRONIC WELDING EQUIPMENT LTD

21 Jubilee Drive, Belton Park, Loughborough
GB-Leicestershire LE11 5XS, Great Britain
Tel. +44 01509/267499, www.migatron.com

France

MIGATRONIC EQUIPEMENT DE SOUDURE S.A.R.L.

Parc Avenir II, 313 Rue Marcel Merieux
FR-69530 Brignais, France
Tel. +33 04 78 50 65 11, www.migatron.com

Italy

MIGATRONIC s.r.l. IMPIANTI PER SALDATURA

Via Dei Quadri 40, IT-20871 Vimercate (MB), Italy
Tel. +39 039 9278093, www.migatron.com

Norway

MIGATRONIC NORGE AS

Industriveien 6, N-3300 Hokksund, Norway
Tel. +47 32 25 69 00, www.migatron.com

Czech Republic

MIGATRONIC CZ a.s.

Tolstého 451, CZ-415 03 Teplice 3, Czech Republic
Tel. +420 411 135 600, www.migatron.com

Holland

MIGATRONIC NEDERLAND B.V.

Ericssonstraat 2, NL-5121 ML Rijen, Holland
Tel. +31 (0)161-747840, www.migatron.com

Sweden

MIGATRONIC SVETSMASKINER AB

Nääs Fabriker, Box 5015,S-448 50 Tollered, Sweden
Tel. +46 031 44 00 45, www.migatron.com

Germany

MIGATRONIC SCHWEISSMASCHINEN GMBH

Sandusweg 12, D-35435 Wettenberg-Launsbach, Germany
Tel. +49 0641/98284-0, www.migatron.com

Hungary

MIGATRONIC KERESKEDELM I KFT.

Futó utca 37. 6. emelet, H-1082 Budapest, Hungary
Tel. +36 70 630 0604 www.migatron.com

MIGATRONIC ASIA:

India

MIGATRONIC INDIA PRIVATE LTD.

No.22 & 39/20H Sowri Street,
IN-Alandur, Chennai – 600 016, India
Tel. +91 44 2233 0074 www.migatron.com