

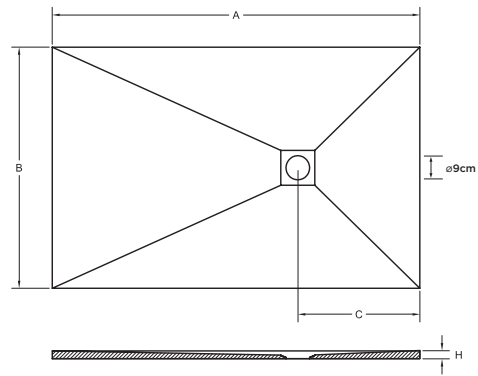

45 kg/m²



ARDOISE
A 700-2100 | B 700-1100
Antidérapant Classe C | PN 24



BOIS
A 700-2100 | B 700-1000
Antidérapant Classe B | PN 18



GRANITE
A 700-2100 | B 700-1000
Antidérapant Classe C | PN 24



CROCODILE
A 700-2100 | B 700-900
Antidérapant Classe B | PN 18

		A (mm)														
		700	800	900	1000	1100	1200	1300	1400	1500	1600	1700	1800	1900	2000	2100
700	C	455	455	455	455	465	465	460	460	460	650	650	650	650	650	650
	H	25	25	25	25	25	25	30	30	30	30	30	30	30	30	30
800	C	455	455	455	455	465	465	460	460	460	650	650	650	650	650	650
	H	25	25	25	25	25	25	30	30	30	30	30	30	30	30	30
900	C	450	500	450	500	490	490	465	465	465	650	650	650	650	650	650
	H	25	25	25	25	25	25	30	30	30	30	30	30	30	30	30
1000	C	450	500	450	500	490	490	465	465	465	650	650	650	650	650	650
	H	25	25	25	25	25	25	30	30	30	30	30	30	30	30	30
1100	C	-	-	-	460	460	460	460	460	460	650	650	650	-	-	-
	H	-	-	-	25	25	25	30	30	30	30	30	-	-	-	-

		A (mm)														
		700	800	900	1000	1100	1200	1300	1400	1500	1600	1700	1800	1900	2000	2100
700	C	455	455	455	455	465	465	465	465	465	650	650	650	650	650	650
	H	25	25	25	25	25	25	30	30	30	30	30	30	30	30	30
800	C	455	455	455	455	465	465	460	460	460	650	650	650	650	650	650
	H	25	25	25	25	25	25	30	30	30	30	30	30	30	30	30
900	C	450	500	450	500	490	490	465	465	465	650	650	650	650	650	650
	H	25	25	25	25	25	25	30	30	30	30	30	30	30	30	30
1000	C	450	500	450	500	490	490	465	465	465	650	650	650	650	650	650
	H	25	25	25	25	25	25	30	30	30	30	30	30	30	30	30

		A (mm)														
		700	800	900	1000	1100	1200	1300	1400	1500	1600	1700	1800	1900	2000	2100
700	C	455	455	455	455	455	455	465	465	465	650	650	650	650	650	650
	H	25	25	25	25	25	25	30	30	30	30	30	30	30	30	30
800	C	455	455	455	455	455	455	465	465	465	650	650	650	650	650	650
	H	25	25	25	25	25	25	30	30	30	30	30	30	30	30	30
900	C	455	455	455	455	455	455	465	465	465	650	650	650	650	650	650
	H	25	25	25	25	25	25	30	30	30	30	30	30	30	30	30

Les caractéristiques techniques peuvent être modifiées sans préavis. Tolérances dimensionnelles +/-5mm.

Couleurs Séries



Couleurs Spéciales



213 Couleurs RAL



Grille



Rebord optionnel



Bondes

BONDE ORIENTABLE DE SÉRIE



BONDE EXTRA FLAT EN OPTION



Garantie 5 ans.



Matériau Quarex. Résine + charge minérale.



Découpe sur mesure. Découpe possible sur un chantier.



Installation: encastrée (valable pour PMR) ou soulevée. Consultez le manuel d'installation.



Produit en Solid White. Blanc Naturel.



Revêtement haute résistance aux UV.



Revêtement de dureté supérieure (<0,01 mm. selon UNE EN 14688; maximum autorisé 0,1 mm).



Revêtement avec une excellente résistance à l'hydrolyse.



Emballage carton doublé cannelure renforcé avec cadre en bois et coins protecteurs.



Traitement Antibactérien R<2 ISO 22196.